

HOW TO READ THE STANDARD OF BORING BARS

● How this section page is organised

- ① Organised by product series.
(Refer to the index on the next page.)

TYPE OF BORING BAR
indicates the initial letters for the order number, as well as applicable insert types.

TITLE OF PRODUCT SERIES

PRODUCT SECTION

PRODUCT FEATURES

FIGURE SHOWING THE TOOLING APPLICATION
uses illustrations and arrows to depict available machining applications along with cutting edge lead angles.

GEOMETRY

CHIP BREAKER BY CUTTING APPLICATION

BORING BARS

DIMPLE BAR

FSCLC/P

Order Number	Stock	Insert Number	DCON	LF	LDRED	WF	H	GAMP	DMIN	Insert l/d Ratio	Wrench
FSCLC1008RL-06S	●	CC BHTW 0802	8	125	18	5	7.2	12°	10	3	TS253 TKY08F
FSCLC1412RL-06S	●	CC BHTW 0802	10	150	22.5	8	9	5°	12	3.5	TS3D TKY10F
FSCLC1612RL-06S	●	CPMB CPMT #2 0903	12	150	30	8	11	4°	14	4	TS3D TKY10F
FSCLC1816RL-06S	●	CPMB CPMT #2 0903	16	180	36	9	15	3.5°	18	5	TS4D TKY15F
FSCLC2220RL-06S	●	CPMB CPMT #2 0903	20	220	45	11	19	2°	22	5	TS4D TKY15F
FSCLC3025RL-06S	●	CPMB CPMT #2 0903	25	250	56.3	15	23.4	0°	30	5	TS4D TKY15F

*1 Clamp Torque (N·m) : TS253=1.0, TS3D=2.5, TS4D=3.5
*2 By changing the clamp screw, it is possible to use the different insert. Please refer to page E007.

FSCLC/P_E

Order Number	Stock	Insert Number	DCON	LF	LDRED	WF	H	GAMP	DMIN	Insert l/d Ratio	Wrench
FSCLC1008RL-06E	●	CC B HTW 0802	8	140	13.8	5	7.2	12°	10	7	TS253 TKY08F
FSCLC1008R-06E-2/3	●	CC H CC W 0802	8	90	13.8	5	7.2	12°	10	5	TS253 TKY08F
FSCLC1008R-06E-1/2	●	CC W 0802	8	70	13.8	5	7.2	12°	10	3	TS253 TKY08F
FSCLC1210RL-08E	●	0802	10	160	16.0	6	9	5°	12	7.5	TS3D TKY10F
FSCLC1210R-08E-2/3	●	0802	10	105	16.0	6	9	5°	12	5	TS3D TKY10F
FSCLC1210R-08E-1/2	●	0802	10	80	16.0	6	9	5°	12	3	TS3D TKY10F
FSCLC1412RL-08E	●	0802	12	180	17.8	7	11	4°	14	8	TS3D TKY10F
FSCLC1412R-08E-2/3	●	0802	12	120	17.8	7	11	4°	14	5	TS3D TKY10F
FSCLC1412R-08E-1/2	●	0802	12	90	17.8	7	11	4°	14	3	TS3D TKY10F
FSCLC1816RL-09E	●	CPMB CPMT #2 0903	16	220	21.8	9	15	3.5°	18	8	TS4D TKY15F
FSCLC1816R-09E-2/3	●	CPMB CPMT #2 0903	16	145	21.8	9	15	3.5°	18	5	TS4D TKY15F
FSCLC1816R-09E-1/2	●	CPMB CPMT #2 0903	16	110	21.8	9	15	3.5°	18	3	TS4D TKY15F
FSCLC2220RL-09E	●	0903	20	250	24.0	11	19	2°	22	8	TS4D TKY15F
FSCLC2220R-09E-2/3	●	0903	20	165	24.0	11	19	2°	22	5	TS4D TKY15F
FSCLC2220R-09E-1/2	●	0903	20	125	24.0	11	19	2°	22	3	TS4D TKY15F

*1 Clamp Torque (N·m) : TS253=1.0, TS3D=2.5, TS4D=3.5
*2 By changing the clamp screw, it is possible to use the different insert. Please refer to page E007.

FSCLC/P

Order Number	Stock	Insert Number	DCON	LF	LDRED	WF	H	GAMP	DMIN	Insert l/d Ratio	Wrench
FSCLC1008RL-06A	●	CC BHTW 0802	8	125	18	5	7.2	12°	10	3	TS253 TKY08F
FSCLC1412RL-06A	●	CPMB CPMT #2 0903	12	150	27	7	11	4°	14	4	TS3D TKY10F
FSCLC1816RL-09A	●	CPMB CPMT #2 0903	16	180	36	9	15	3.5°	18	5	TS4D TKY15F
FSCLC2220RL-09A	●	CPMB CPMT #2 0903	20	220	45	11	19	2°	22	5	TS4D TKY15F
FSCLC3025RL-09A	●	CPMB CPMT #2 0903	25	250	56.3	15	23.4	0°	30	5	TS4D TKY15F

*1 Clamp Torque (N·m) : TS253=1.0, TS3D=2.5, TS4D=3.5
*2 By changing the clamp screw, it is possible to use the different insert. Please refer to page E007.

Legend for Stock Status Mark
is shown on the left hand page of each double-page spread.

Product Standards
indicates order numbers, stock status (per right/left hand), applicable inserts, dimensions, minimum cutting diameters, standard corner radius, recommended l/d ratios, and spare parts.

Min. Cutting Diameter
is colour-coded to let you find, at a glance, the maximum / minimum cutting diameters for internal machining.

Reference Page for Applicable Inserts
indicates reference pages for details of inserts that are applicable to the title product.

Page Reference
indicates reference pages, including the above, on the right hand page of each double-page spread.

Legend for Stock Status Mark
● Inventory maintained in Japan.

Legend for Applicable Inserts
CC type inserts > A114-A121
CP type inserts > A122, A123
CBN & PCD inserts > B040-B043, B059

Legend for Page Reference
CUTTING CONDITIONS > E020
SPARE PARTS > P001
TECHNICAL DATA > Q001

- To Order : Please specify
- ① order number and hand of tool (right/left).

TURNING TOOLS

BORING BARS

CLASSIFICATION OF BORING TOOLS	E002
IDENTIFICATION	E004

STANDARD OF BORING BARS







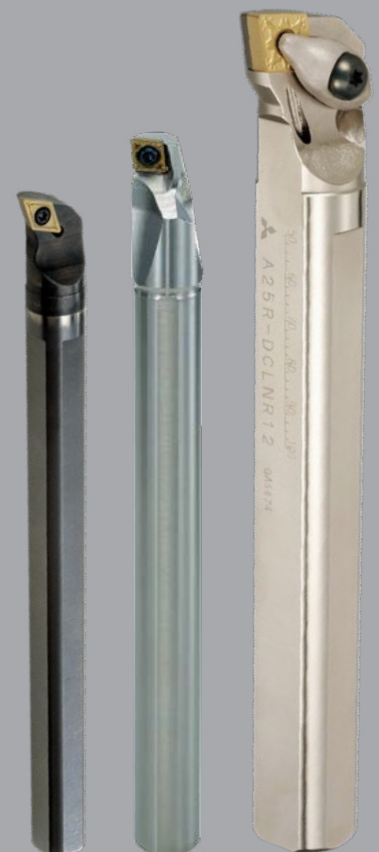



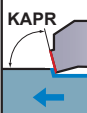
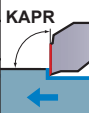
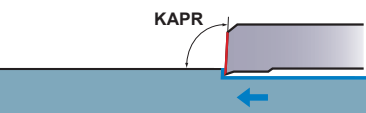

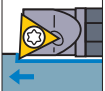
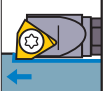
FEATURES OF DIMPLE BAR	E005
DIMPLE BAR.....	E006
DOUBLE CLAMP DIMPLE BAR.....	E013
MICRO-DEX BORING BARS.....	E016
MICRO-MINI TWIN BORING BARS	E019
MICRO-MINI BORING BARS.....	E022
F TYPE BORING BARS.....	E025
S TYPE BORING BARS.....	E028
P TYPE BORING BARS.....	E035
M TYPE BORING BARS	E039
D TYPE BORING HEAD	E040
AL TYPE BORING BARS	E043

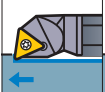
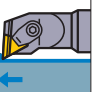
*Arranged by Alphabetical order

E021 A○○○-DCLN	E037 C○○○SDUC	E010 FSTUP
E021 A○○○-DDUN	E036 C○○○STFC	E020 FSVJB/C
E022 A○○○-DSKN	E025 C○○○STUC	E019 FSVPB/C
E022 A○○○-DTFN	E040 C○○○SVQC	E018 FSVUB/C
E023 A○○○-DVUN	E024 C○○○SWUB	E035 FSWL1
E023 A○○○-DWLN	E027 CB	E035 FSWL2
E047 A○○○MWLN	E028 CR	E016 FSWUB/P
E044 A○○○PCLN	E049 DPCL	E026 RBH
E045 A○○○PDQN	E049 DPDH	E031 RBH
E044 A○○○PDUN	E048 DPDU	E038 S○○○SCLC
E046 A○○○PDZN	E048 DPTF	E042 S○○○SCZC
E043 A○○○PSKN	E050 DPVP	E039 S○○○SDQC
E043 A○○○PTFN	E034 FCTU1	E037 S○○○SDUC
E045 A○○○PWLN	E034 FCTU2	E041 S○○○SSKC
E050 B1○○○○	E008 FSCLC/P	E036 S○○○STFC
E030 C○○○-BLS	E014 FSDQC	E051 STFE
E024 C○○○SCLC	E012 FSDUC	E040 S○○○SVQC
E038 C○○○SCLC	E033 FSTU1	E041 S○○○SVUC
E039 C○○○SDQC	E033 FSTU2	E032 SBH

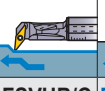

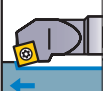
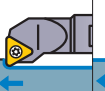

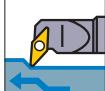











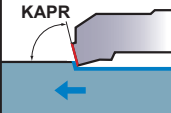
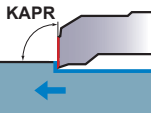
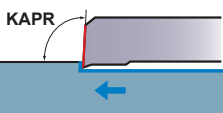

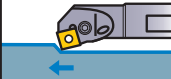

CLASSIFICATION

Applicable Insert Type			SC	TC	DC	TC/TP	TP	VB/VC	WB/WP
Name of Tool Holder	DMIN Minimum Cutting Diameter	Features	KAPR=75°	KAPR=91°	KAPR=93°				
MICRO-MINI TWIN Boring Bars 	$\phi 2.2$ — $\phi 8.2$	<ul style="list-style-type: none"> ● Solid carbide type with two cutting edges. ● Continuous cutting from boring to facing. ● With or without a chip breaker. 							
MICRO-MINI Boring Bars 	$\phi 3.2$ — $\phi 5.2$	<ul style="list-style-type: none"> ● Solid carbide type (Single cutting edges). ● l/d is 5 times the diameter. ● Cutting edge can be shaped according to the application. Thus, it covers a wide cutting range (threading, grooving, copying, etc.). 							
MICRO-DEX Boring Bars (Carbide Shank) 	$\phi 5$ — $\phi 8$	<ul style="list-style-type: none"> ● 7° positive insert. ● Carbide shank type. ● Easy-to-use tool geometries. ● Suitable for small workpieces. ● l/d is 5 times the diameter. 				 STUC ↻ E025		 SWUB ↻ E024	
F Type Boring Bars 	$\phi 5.8$ — $\phi 40$	<ul style="list-style-type: none"> ● 11° positive insert. ● Screw-on type and Clamp-on type. ● l/d is 3 to 5 times the diameter. ● FSWL type is 7° positive insert. 				 FSTU ↻ E033	 FCTU ↻ E034		
DIMPLE BAR 	$\phi 10$ — $\phi 40$	<ul style="list-style-type: none"> ● 5°, 7°, 11° positive insert. ● Excellent vibration resistance due to a light dimple head. ● l/d is 3 to 5 times the diameter (Carbide shank is 3 to 8 times the diameter). 				 FSDUC ↻ E012	 FSTUP ↻ E010	 FSVUB/C ↻ E018	 FSWUB/P ↻ E016
S Type Boring Bars 	$\phi 11$ — $\phi 50$	<ul style="list-style-type: none"> ● ISO standard. ● 7° positive insert. ● Screw-on type. ● l/d is 3 to 5 times the diameter (Carbide shank is 7 times the diameter). 	 SSKC ↻ E041	 STFC ↻ E036	 SDUC ↻ E037			 SVUC ↻ E041	

Note 1) Holders with blue colour symbol have an anti-vibration carbide shank. (For Micro-dex boring bars, carbide shank only.)

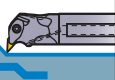

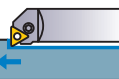
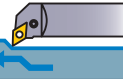



Note 2) l/d represents the ratio of the projection length L to the cutting edge and the shank diameter d.

CLASSIFICATION

Applicable Insert Type			SN ^{○○} 	TE/TN ^{○○} 	DN ^{○○} 	VN ^{○○} 
Name of Tool Holder	DMIN Minimum Cutting Diameter	Features	KAPR=75° 	KAPR=91° 	KAPR=93° 	
AL Type Boring Bars (For Aluminium Alloy) 	φ20 — φ32	<ul style="list-style-type: none"> ● Suitable for non-ferrous metal. ● 20° positive insert. ● Screw-on type. ● l/d is 6 times the diameter. ● Excellent vibration resistance. 		 STFE ↻ E051		
P Type Boring Bars 	φ20 — φ70	<ul style="list-style-type: none"> ● ISO standard. ● Economical negative insert. ● Lever lock type, and pin lock type. ● l/d is 3 times the diameter. 	 PSKN ↻ E043	 PTFN ↻ E043	 PDUN ↻ E044	
DOUBLE CLAMP DIMPLE BAR 	φ32 — φ50	<ul style="list-style-type: none"> ● Economical negative insert. ● Single action type. ● Excellent vibration resistance due to a light dimple head. (With coolant hole.) ● l/d is 3 to 4 times the diameter. 	 DSKN ↻ E022	 DTFN ↻ E022	 DDUN ↻ E021	 DVUN ↻ E023
D Type Boring Head 	φ40 — φ60	<ul style="list-style-type: none"> ● Economical negative insert. ● Lever lock type. ● Exchangeable head type. 		 DPTF ↻ E048	 DPDU ↻ E048	
M Type Boring Bars 	φ63	<ul style="list-style-type: none"> ● Negative trigon shape insert. ● Double clamp type. ● l/d is 3 times the diameter. 				

Note 1) Holders with blue colour symbol have an anti-vibration carbide shank. (For Micro-dex boring bars, carbide shank only.)

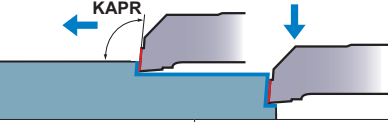
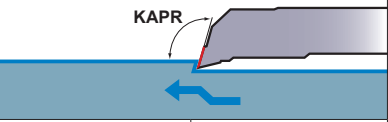
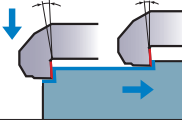
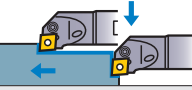
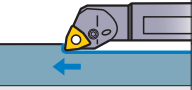
Note 2) l/d represents the ratio of the projection length L to the cutting edge and the shank diameter d.

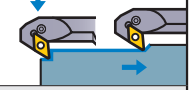
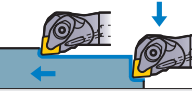
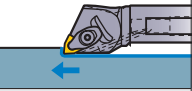
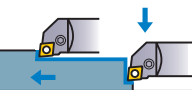
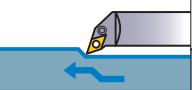
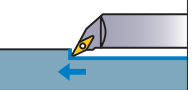
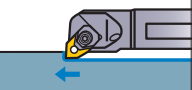
	CN ^{○○} 	WN ^{○○} 	DN ^{○○} 	VN ^{○○} 	DN ^{○○} 	Selection Standard								
	KAPR=95° 		KAPR=107.5°–117.5° 		KAPR=3°, 5° 		Economical	Low Cutting Resistance (Sharpness)	Clamp Rigidity	Vibration Resistance	Operation Efficiency	Coolant Hole	Specialized	Small Diameter Cutting
							⊙	⊙	○				⊙	
	 PCLN ⊕ E044	 PWLN ⊕ E045	 PDQN ⊕ E045			 PDZN ⊕ E046	⊙		○	⊙	⊙			
	 DCLN ⊕ E021	 DWLN ⊕ E023					⊙	⊙	⊙	⊙				
	 DPCL ⊕ E049		 DPDH ⊕ E049	 DPVP ⊕ E050			⊙	○	○	⊙				
		 MWLN ⊕ E047					⊙	⊙	○	○				

Note 3) ⊙ : 1st recommendation. ○ : 2nd recommendation.

IDENTIFICATION

■ DIMPLE BAR

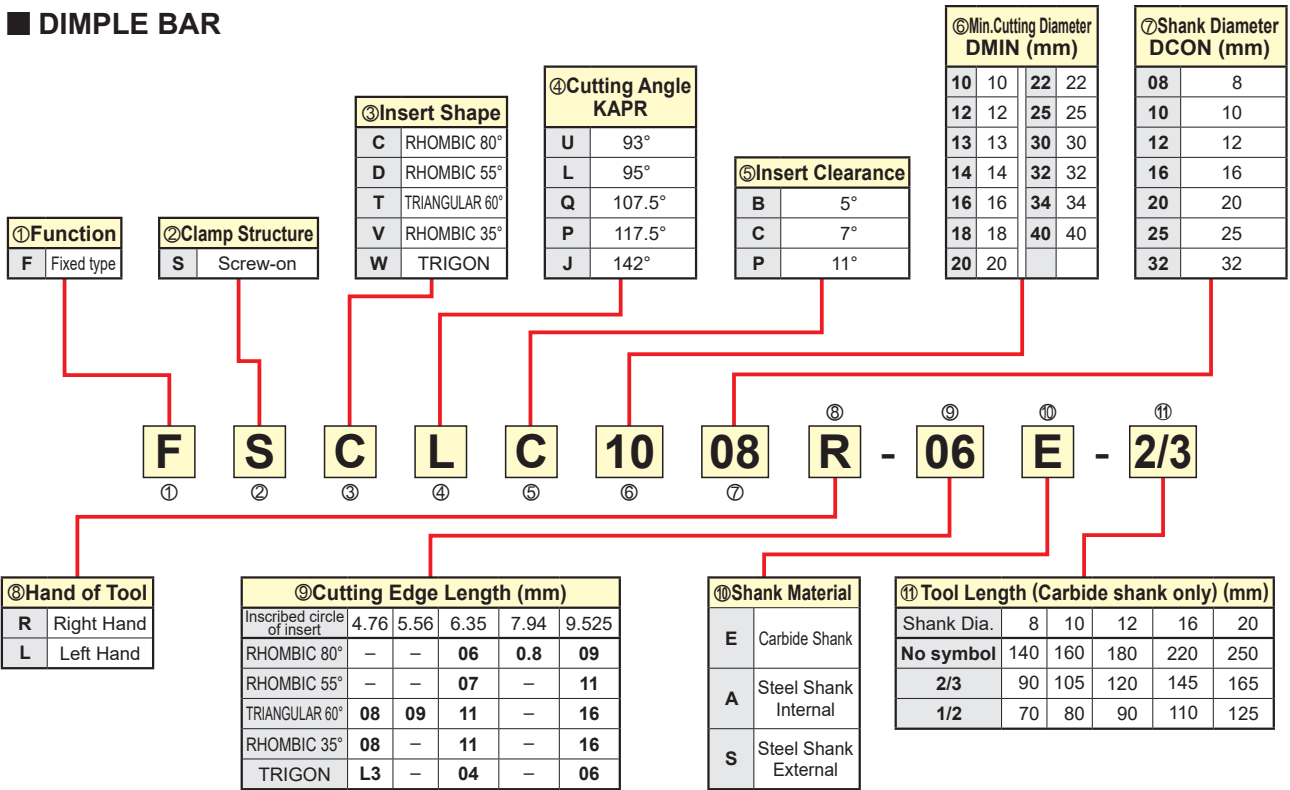

BORING BARS

■ ISO TYPE BORING TOOLS

[For Aluminium Alloy, P-type and S-type]

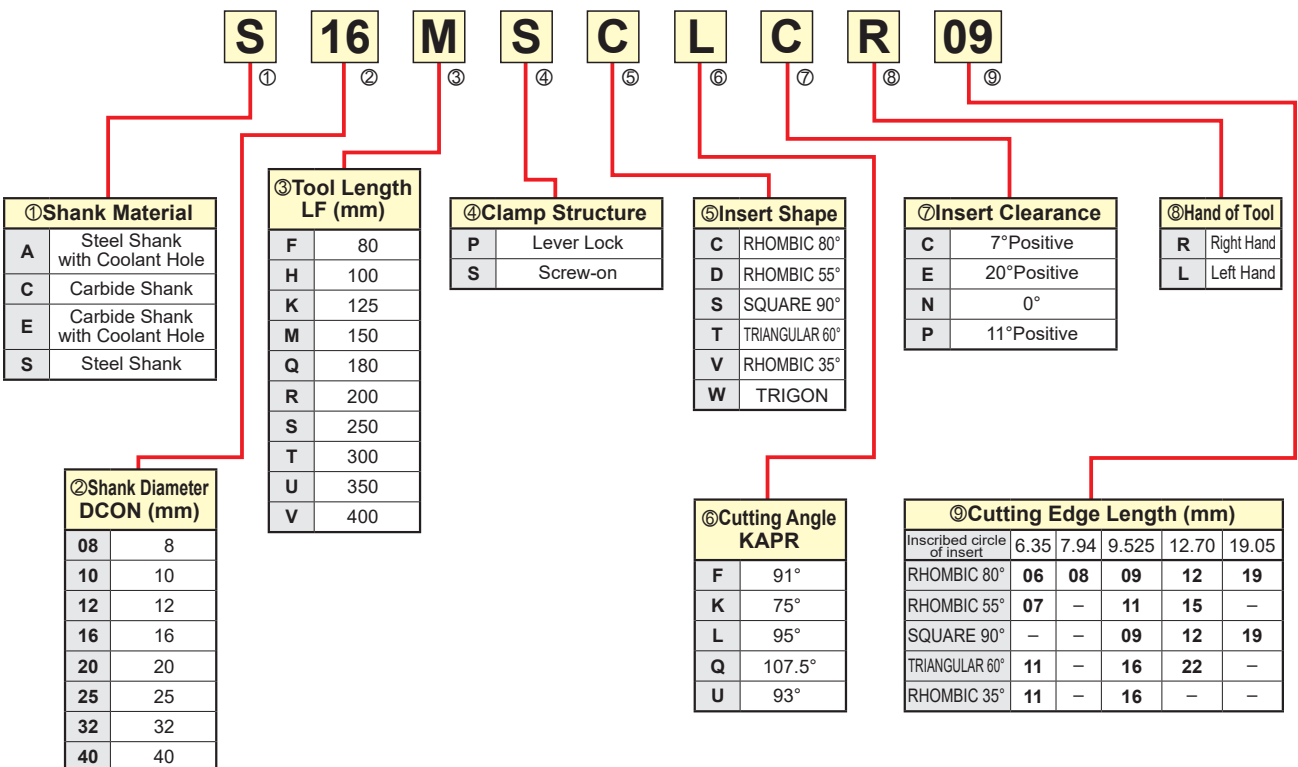

FEATURES OF DIMPLE BAR

Highly rigid steel shank and a lightweight head configuration designed by computer simulation analysis reduces chatter and improves the vibration damping properties.

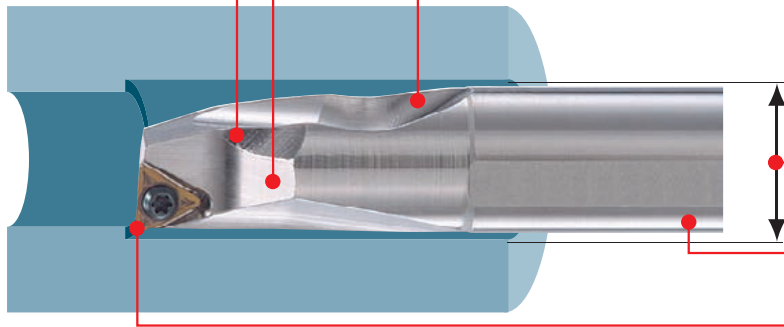

Chip disposal is improved by having two channels for chip evacuation.

The lightweight head with its large dimple reduces chatter.

Available in sizes smaller than the ISO standard. Therefore the boring of small diameter holes is possible.

The boring bar has a laser printed scale on the shank to facilitate easy installation.

"F and FS" breakers improves the quality of the surface finish, "MV" breaker offers excellent chip disposal. High wear resistant CBN inserts are also available for the machining of hardened materials.

E

BORING BARS

VIBRATION RESISTANCE

● DIMPLE BAR

Weight of the Head	Damping Time
49.7g	15.8ms



By reducing the weight of the head, the damping properties are increased.

● Conventional Product

Weight of the Head	Damping Time
70.1g	20ms

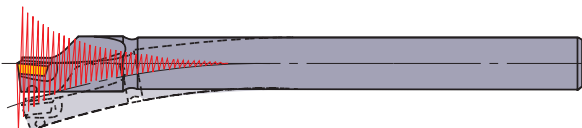

CUTTING PERFORMANCE

SCM440 Steel Shank Comparison of Surface Roughness

Internal coolant improves chip evacuation, suppresses chips scraping the machined surface, and improves surface roughness.

	Measured Value	Ra
NEW Steel shank with coolant hole		1.4μm
Steel shank without coolant hole		2.4μm

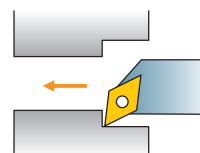

<Cutting Conditions>

Workpiece Material : JIS SCM400
 Tool : KAPR 93°
 Inserts : DCMT070204-MV
 Cutting Speed : vc=80 m/min
 Feed per Rev. : f=0.1 mm/rev
 Depth of Cut : ap=0.5mm
 Cutting Mode : Wet Cutting Internal vs External
 (Water-Soluble Cutting Fluid)

* The simulation data stated above was conducted with a FSCLP1816R-09S holder, under the following conditions; l/d=5, depth of cut=0.5mm, and feed=0.05mm/rev.

Direction for the use of CCG/MT • CPG/MT • CPMX • TPG/MX type inserts

By changing the clamp screw, it is possible to use the inserts listed in the table below.

Holder : FSCLC/P • FSCLC/P...E

Insert Number	Clamp Screw
CCG/MT0602 (φ6.35)	Can be used as it is.
CPG/MT0802 (φ7.94)	Change to TS3
CPG/MT0903 (φ9.525)	Change to TS4
CPMX0802 (φ7.94)	Can be used as it is.
CPMX0903 (φ9.525)	Can be used as it is.

Holder : FSTUP • FSTUP...E

Insert Number	Clamp Screw
TPG/MX0802 (φ4.76)	Change to CS200T
TPG/MX0902 (φ5.56)	Change to CS250T
TPG/MX1103 (φ6.35)	Change to CS300890T

* If the screw is too long the please shorten as necessary.

Note 1) TPMT/W09, W11 types cannot be used due to a different clamp screw size.

BORING BARS

DIMPLE BAR

- Excellent vibration resistance due to light dimple head.
- Chip disposal is improved by having two channels for chip evacuation.
- A laser printed scale on the side for easy installation (Steel shank).
- l/d is 3 to 5 times the diameter (Carbide shank is 3 to 8 times the diameter).



Order Number		Stock		Insert Number	Dimensions(mm)						Maximum Recommendation l/d Ratio	*1			
					DCON	LF	LDRED	WF	H	GAMF		DMIN	Clamp Screw	Wrench	
FSCLC1008R/L-06S		●	●	CC○B/H/T/W	0602○	8	125	18	5	7.2	12°	10	3	TS253	TKY08F
FSCLP1210R/L-08S		●	●	CPMB CPMH CPMT *2 CPMX *2 CPGB CPGT *2	0802○	10	150	22.5	6	9	5°	12	3.5	TS3D	TKY10F
FSCLP1412R/L-08S		●	●		0802○	12	150	27	7	11	4°	14	4	TS3D	TKY10F
FSCLP1612R/L-09S		●	●		0903○	12	150	30	8	11	4°	16	4	TS4D	TKY15F
FSCLP1816R/L-09S		●	●		0903○	16	180	36	9	15	3.5°	18	5	TS4D	TKY15F
FSCLP2220R/L-09S		●	●		0903○	20	220	45	11	19	2°	22	5	TS4D	TKY15F
FSCLP3025R/L-09S		●	●		0903○	25	250	56.3	15	23.4	0°	30	5	TS4D	TKY15F

*1 Clamp Torque (N · m) : TS253=1.0, TS3D=2.5, TS4D=3.5

*2 By changing the clamp screw, it is possible to use the different insert. Please refer to page E007.

Order Number		Stock		Insert Number	Dimensions(mm)						Maximum Recommendation l/d Ratio	*1			
					DCON	LF	LDRED	WF	H	GAMF		DMIN	Clamp Screw	Wrench	
FSCLC1008R/L-06A		●	●	CC○B/H/T/W	0602○	8	125	18	5	7.2	12°	10	3	TS253	TKY08F
FSCLP1210R/L-08A		●	●	CPMB CPMH CPMT *2 CPMX *2 CPGB CPGT *2	0802○	10	150	22.5	6	9	5°	12	3.5	TS3D	TKY10F
FSCLP1412R/L-08A		●	●		0802○	12	150	27	7	11	4°	14	4	TS3D	TKY10F
FSCLP1816R/L-09A		●	●		0903○	16	180	36	9	15	3.5°	18	5	TS4D	TKY15F
FSCLP2220R/L-09A		●	●		0903○	20	220	45	11	19	2°	22	5	TS4D	TKY15F
FSCLP3025R/L-09A		●	●		0903○	25	250	56.3	15	23.4	0°	30	5	TS4D	TKY15F

*1 Clamp Torque (N · m) : TS253=1.0, TS3D=2.5, TS4D=3.5

*2 By changing the clamp screw, it is possible to use the different insert. Please refer to page E007.

● = NEW

Note 1) The insert photos are only examples. The letters refer to the chip breaker and the dimension refers to the inscribed circle.

Note 2) Dimensions shown for insert corner RE 0.4. (Model of ☆ Mark is RE 0.8)

Note 3) When using insert with right and left hand chip breaker, please use left hand insert for right hand holder and right hand insert for left hand holder.

● : Inventory maintained in Japan.

CC○ type inserts > A114–A121

CP○ type inserts > A122, A123

CBN & PCD inserts > B040–B043, B059

FSCLC/P_E

Carbide shank with coolant hole CC^oinserts, CP^oinserts

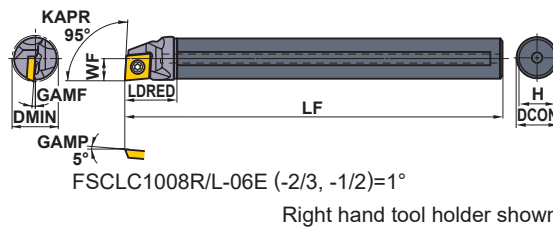
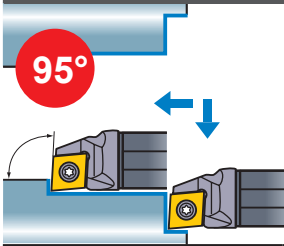

Finish	Finish	Finish	Light
FP (06)	FV (06,08,09)	FM (06)	SV (06,08,09)
Light	Medium	Medium	CBN/PCD
LP (06)	MV (06,08,09)	MP (06)	(06,08,09)

Order Number	Stock		Insert Number	Dimensions(mm)							Maximum Recommendation l/d Ratio	*1		
	R	L		DCON	LF	LDRED	WF	H	GAMF	DMIN		Clamp Screw	Wrench	
FSCLC1008R/L-06E	●	●	CC ^o B	0602 ^o	8	140	13.8	5	7.2	12°	10	7	TS253	TKY08F
FSCLC1008R-06E-2/3	●		CC ^o H	0602 ^o	8	90	13.8	5	7.2	12°	10	5	TS253	TKY08F
FSCLC1008R-06E-1/2	●		CC ^o T	0602 ^o	8	70	13.8	5	7.2	12°	10	3	TS253	TKY08F
FSCLC1008R-06E-1/2	●		CC ^o W	0602 ^o	8	70	13.8	5	7.2	12°	10	3	TS253	TKY08F
FSCLP1210R/L-08E	●	●	CPMB CPMH CPMT *2 CPMX *2 CPGB CPGT *2	0802 ^o	10	160	16.0	6	9	5°	12	7.5	TS3D	TKY10F
FSCLP1210R-08E-2/3	●			0802 ^o	10	105	16.0	6	9	5°	12	5	TS3D	TKY10F
FSCLP1210R-08E-1/2	●			0802 ^o	10	80	16.0	6	9	5°	12	3	TS3D	TKY10F
FSCLP1412R/L-08E	●	●		0802 ^o	12	180	17.8	7	11	4°	14	8	TS3D	TKY10F
FSCLP1412R-08E-2/3	●			0802 ^o	12	120	17.8	7	11	4°	14	5	TS3D	TKY10F
FSCLP1412R-08E-1/2	●			0802 ^o	12	90	17.8	7	11	4°	14	3	TS3D	TKY10F
FSCLP1816R/L-09E	●	●		0903 ^o	16	220	21.8	9	15	3.5°	18	8	TS4D	TKY15F
FSCLP1816R-09E-2/3	●			0903 ^o	16	145	21.8	9	15	3.5°	18	5	TS4D	TKY15F
FSCLP1816R-09E-1/2	●			0903 ^o	16	110	21.8	9	15	3.5°	18	3	TS4D	TKY15F
FSCLP2220R/L-09E	●	●		0903 ^o	20	250	24.0	11	19	2°	22	8	TS4D	TKY15F
FSCLP2220R-09E-2/3	●			0903 ^o	20	165	24.0	11	19	2°	22	5	TS4D	TKY15F
FSCLP2220R-09E-1/2	●			0903 ^o	20	125	24.0	11	19	2°	22	3	TS4D	TKY15F

*1 Clamp Torque (N • m) : TS253=1.0, TS3D=2.5, TS4D=3.5

*2 By changing the clamp screw, it is possible to use the different insert. Please refer to page E007.

CC ^o type inserts	> A114–A121
CP ^o type inserts	> A122, A123
CBN & PCD inserts	> B040–B043, B059

CUTTING CONDITIONS	> E020
SPARE PARTS	> P001
TECHNICAL DATA	> Q001

BORING BARS

DIMPLE BAR

- Excellent vibration resistance due to light dimple head.
- Chip disposal is improved by having two channels for chip evacuation.
- A laser printed scale on the side for easy installation (Steel shank).
- l/d is 3 to 5 times the diameter (Carbide shank is 3 to 8 times the diameter).



FSTUP

TP^{○○}inserts

Finish	Light	Medium
FV  (08,09,11,16)	SV  (08,09,11,16)	MV  (08,09,11,16)
PCD	CBN	
R/L-F  (08,09,11,16)	 (08,09,11,16)	

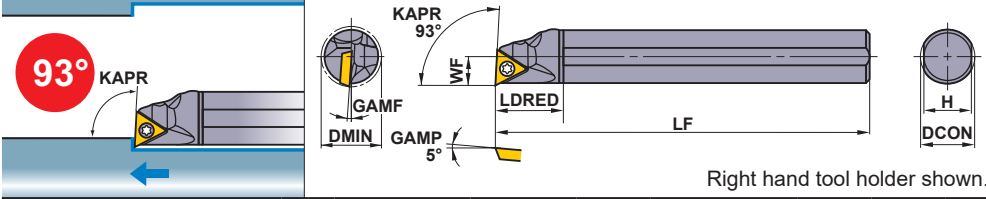

Order Number	Stock		Insert Number	Dimensions(mm)							Maximum Recommendation l/d Ratio	*1		
	R	L		DCON	LF	LDRED	WF	H	GAMF	DMIN		Clamp Screw	Wrench	
FSTUP1008R/L-08S	●	●	TPMB TPMH TPMX*2 TPGB TPGH TPGX*2	0802 ^{○○}	8	125	18	5	7.2	10°	10	3	TS2D	TKY06F
FSTUP1210R/L-09S	●	●		0902 ^{○○}	10	150	22.5	6	9	8°	12	3.5	TS25D	TKY08F
FSTUP1412R/L-09S	●	●		0902 ^{○○}	12	150	27	7	11	7°	14	4	TS25D	TKY08F
FSTUP1210R/L-11S	●	●		1103 ^{○○}	10	150	22.5	6	9	8°	12	3.5	TS31D	TKY10F
FSTUP1412R/L-11S	●	●		1103 ^{○○}	12	150	27	7	11	7°	14	4	TS31D	TKY10F
FSTUP1816R/L-11S	●	●		1103 ^{○○}	16	180	36	9	15	4°	18	5	TS31D	TKY10F
FSTUP2220R/L-11S	●	●		1103 ^{○○}	20	220	45	11	19	0°	22	5	TS31D	TKY10F
FSTUP3225R/L-16S ☆	●	●		1603 ^{○○}	25	270	56.3	16	23.4	0°	32	5	TS4D	TKY15F

* Clamp Torque (N · m) : TS2D=0.6, TS25D=1.0, TS31D=2.5, TS4D=3.5

*2 By changing the clamp screw, it is possible to use the different insert. Please refer to page E007.

BORING BARS



E

FSTUP

NEW

Steel shank with coolant hole

TP^{○○}inserts

Finish	Light	Medium
FV  (08,09,11,16)	SV  (08,09,11,16)	MV  (08,09,11,16)
PCD	CBN	
R/L-F  (08,09,11,16)	 (08,09,11,16)	

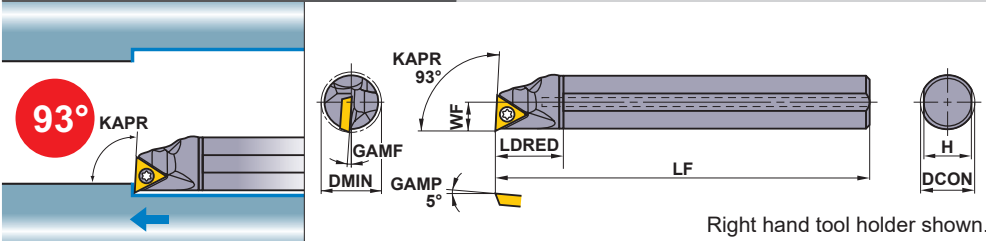

Order Number	Stock		Insert Number	Dimensions(mm)							Maximum Recommendation l/d Ratio	*1		
	R	L		DCON	LF	LDRED	WF	H	GAMF	DMIN		Clamp Screw	Wrench	
FSTUP1008R/L-08A	●	●	TPMB TPMH TPMX*2 TPGB TPGH TPGX*2	0802 ^{○○}	8	125	18	5	7.2	10°	10	3	TS2D	TKY06F
FSTUP1210R/L-09A	●	●		0902 ^{○○}	10	150	22.5	6	9	8°	12	3.5	TS25D	TKY08F
FSTUP1412R/L-09A	●	●		0902 ^{○○}	12	150	27	7	11	7°	14	4	TS25D	TKY08F
FSTUP1816R/L-11A	●	●		1103 ^{○○}	16	180	36	9	15	4°	18	5	TS31D	TKY10F
FSTUP2220R/L-11A	●	●		1103 ^{○○}	20	220	45	11	19	0°	22	5	TS31D	TKY10F
FSTUP3225R/L-16A ☆	●	●		1603 ^{○○}	25	270	56.3	16	23.4	0°	32	5	TS4D	TKY15F

* Clamp Torque (N · m) : TS2D=0.6, TS25D=1.0, TS31D=2.5, TS4D=3.5

*2 By changing the clamp screw, it is possible to use the different insert. Please refer to page E007.

● = **NEW**

Note 1) The insert photos are only examples. The letters refer to the chip breaker and the dimension refers to the inscribed circle.

Note 2) Dimensions shown for insert corner RE 0.4. (Model of ☆ Mark is RE 0.8)

Note 3) When using insert with right and left hand chip breaker, please use left hand insert for right hand holder and right hand insert for left hand holder.



● : Inventory maintained in Japan.

TP^{○○} type inserts > A139 – A141
CBN & PCD inserts > B047, B048, B062, B063

FSTUP_E

Carbide shank
with coolant hole

TP \odot inserts

Finish	Light	Medium
FV  (08,09,11)	SV  (08,09,11)	MV  (08,09,11)
PCD	CBN	
R/L-F  (08,09,11)	 (08,09,11)	

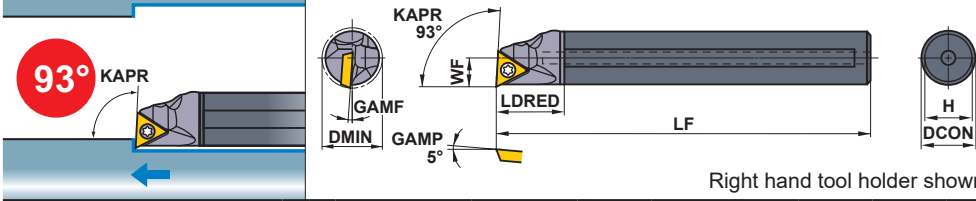

Order Number	Stock		Insert Number	Dimensions(mm)							Maximum Recommendation l/d Ratio	*1		
	R	L		DCON	LF	LDRED	WF	H	GAMF	DMIN		Clamp Screw	Wrench	
FSTUP1008R/L-08E	●	●	TPMB TPMH TPMX*2 TPGB TPGH TPGX*2	0802 \odot	8	140	13.8	5	7.2	10°	10	7	TS2D	TKY06F
FSTUP1008R-08E-2/3	●			0802 \odot	8	90	13.8	5	7.2	10°	10	5	TS2D	TKY06F
FSTUP1008R-08E-1/2	●			0802 \odot	8	70	13.8	5	7.2	10°	10	3	TS2D	TKY06F
FSTUP1210R/L-09E	●	●		0902 \odot	10	160	16.0	6	9	8°	12	7.5	TS25D	TKY08F
FSTUP1210R-09E-2/3	●			0902 \odot	10	105	16.0	6	9	8°	12	5	TS25D	TKY08F
FSTUP1210R-09E-1/2	●			0902 \odot	10	80	16.0	6	9	8°	12	3	TS25D	TKY08F
FSTUP1412R/L-09E	●	●		0902 \odot	12	180	17.8	7	11	7°	14	8	TS25D	TKY08F
FSTUP1412R-09E-2/3	●			0902 \odot	12	120	17.8	7	11	7°	14	5	TS25D	TKY08F
FSTUP1412R-09E-1/2	●			0902 \odot	12	90	17.8	7	11	7°	14	3	TS25D	TKY08F
FSTUP1816R/L-11E	●	●		1103 \odot	16	220	21.8	9	15	4°	18	8	TS31D	TKY10F
FSTUP1816R-11E-2/3	●			1103 \odot	16	145	21.8	9	15	4°	18	5	TS31D	TKY10F
FSTUP1816R-11E-1/2	●			1103 \odot	16	110	21.8	9	15	4°	18	3	TS31D	TKY10F
FSTUP2220R/L-11E	●	●		1103 \odot	20	250	24.0	11	19	0°	22	8	TS31D	TKY10F
FSTUP2220R-11E-2/3	●			1103 \odot	20	165	24.0	11	19	0°	22	5	TS31D	TKY10F
FSTUP2220R-11E-1/2	●			1103 \odot	20	125	24.0	11	19	0°	22	3	TS31D	TKY10F

*1 Clamp Torque (N · m) : TS2D=0.6, TS25D=1.0, TS31D=2.5

*2 By changing the clamp screw, it is possible to use the different insert. Please refer to page E007.

BORING BARS

TP \odot type inserts > A139–A141
CBN & PCD inserts > B047, B048, B062, B063

CUTTING CONDITIONS > E020
SPARE PARTS > P001
TECHNICAL DATA > Q001

BORING BARS

DIMPLE BAR

- Excellent vibration resistance due to light dimple head.
- Chip disposal is improved by having two channels for chip evacuation.
- A laser printed scale on the side for easy installation (Steel shank).
- l/d is 3 to 5 times the diameter (Carbide shank is 3 to 8 times the diameter).



FSDUC

DC \odot inserts

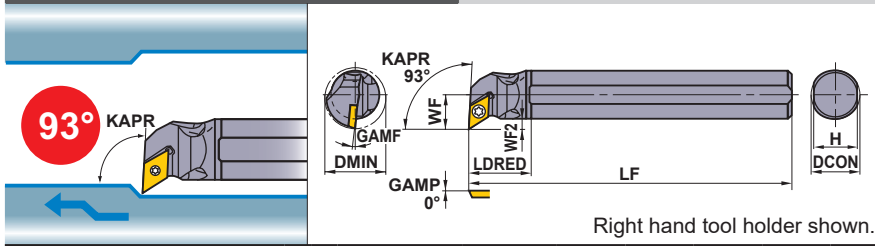

Finish	Finish	Light	Light
FP (07,11)	FM (07,11)	LP (07,11)	LM (07,11)
Medium	Medium	PCD	CBN
MP (07,11)	MM (07,11)	R/L-F (07,11)	(07,11)

Order Number	Stock		Insert Number	Dimensions(mm)								Maximum Recommendation l/d Ratio	*		
	R	L		DCON	LF	LDRED	WF	WF2	H	GAMP	DMIN		Clamp Screw	Wrench	
FSDUC1410R/L-07S	●	●	DCET	0702 \odot	10	150	18	8.3	3.3	9	7.5°	14	3.5	TS25	TKY08F
FSDUC1612R/L-07S	●	●	DCMT	0702 \odot	12	150	20	9.3	3.3	11	6°	16	4	TS25	TKY08F
FSDUC2016R/L-07S	●	●	DCMW	0702 \odot	16	180	20	11.3	3.3	15	5°	20	5	TS25	TKY08F
FSDUC3220R/L-11S [☆]	●	●	DCGT	0702 \odot	20	180	22.5	16.1	6.1	19	5°	32	5	TS43	TKY15F
			DCGW	11T3 \odot											

* Clamp Torque (N · m) : TS25=1.0, TS43=3.5

BORING BARS

FSDUC

NEW

Steel shank with coolant hole

DC \odot inserts

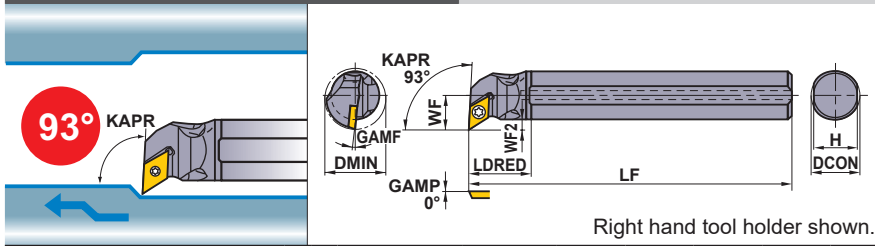

Finish	Finish	Light	Light
FP (07,11)	FM (07,11)	LP (07,11)	LM (07,11)
Medium	Medium	PCD	CBN
MP (07,11)	MM (07,11)	R/L-F (07,11)	(07,11)

Order Number	Stock		Insert Number	Dimensions(mm)								Maximum Recommendation l/d Ratio	*		
	R	L		DCON	LF	LDRED	WF	WF2	H	GAMP	DMIN		Clamp Screw	Wrench	
FSDUC1410R/L-07A	●	●	DCET	0702 \odot	10	150	18	8.3	3.3	9	7.5°	14	3.5	TS25	TKY08F
FSDUC1612R/L-07A	●	●	DCMT	0702 \odot	12	150	20	9.3	3.3	11	6°	16	4	TS25	TKY08F
FSDUC2016R/L-07A	●	●	DCMW	0702 \odot	16	180	20	11.3	3.3	15	5°	20	5	TS25	TKY08F
FSDUC3220R/L-11A [☆]	●	●	DCGT	0702 \odot	20	180	22.5	16.1	6.1	19	5°	32	5	TS43	TKY15F
			DCGW	11T3 \odot											

* Clamp Torque (N · m) : TS25=1.0, TS43=3.5

● = **NEW**

Note 1) The insert photos are only examples. The letters refer to the chip breaker and the dimension refers to the inscribed circle.

Note 2) Dimensions shown for insert corner RE 0.4. (Model of ☆ Mark is RE 0.8)

Note 3) When using insert with right and left hand chip breaker, please use left hand insert for right hand holder and right hand insert for left hand holder.

● : Inventory maintained in Japan.

DC \odot type inserts > A124–A129
CBN & PCD inserts > B044, B045, B060

FSDUC_E

Carbide shank with coolant hole **DC** inserts

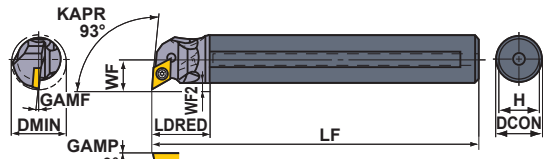
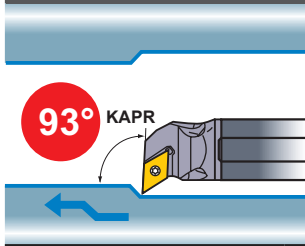

Right hand tool holder shown.

Finish	Finish	Light	Light
FP (07,11)	FM (07,11)	LP (07,11)	LM (07,11)
Medium	Medium	PCD	CBN
MP (07,11)	MM (07,11)	R/L-F (07,11)	 (07,11)

Order Number	Stock		Insert Number	Dimensions(mm)								Maximum Recommendation I/d Ratio	* 		
	R	L		DCON	LF	LDRED	WF	WF2	H	GAMF	DMIN		Clamp Screw	Wrench	
FSDUC1410R/L-07E	●	●	DCET DCMT DCMW DCGT DCGW	0702	10	160	16.0	8.3	3.3	9	7.5°	14	7.5	TS25	TKY08F
FSDUC1612R/L-07E	●	●		0702	12	180	17.8	9.3	3.3	11	6.0°	16	8	TS25	TKY08F
FSDUC2016R/L-07E	●	●		0702	16	220	21.8	11.3	3.3	15	5.0°	20	8	TS25	TKY08F
FSDUC3220R/L-11E [☆]	●	●		11T3	20	250	24.0	16.1	6.1	19	5.0°	32	8	TS43	TKY15F

* Clamp Torque (N • m) : TS25=1.0, TS43=3.5

BORING BARS

DC type inserts > A124–A129
CBN & PCD inserts > B044, B045, B060

CUTTING CONDITIONS > E020
SPARE PARTS > P001
TECHNICAL DATA > Q001

BORING BARS

DIMPLE BAR







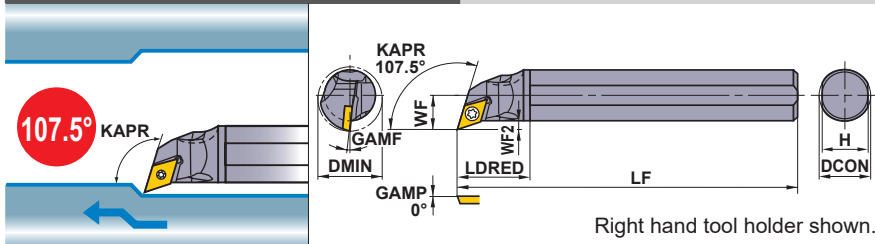

- Excellent vibration resistance due to light dimple head.
- Chip disposal is improved by having two channels for chip evacuation.
- A laser printed scale on the side for easy installation (Steel shank).
- l/d is 3 to 5 times the diameter (Carbide shank is 3 to 8 times the diameter).



FSDQC

DC \odot inserts



Finish	Finish	Light	Light
FP	FM	LP	LM
 (07,11)	 (07,11)	 (07,11)	 (07,11)
Medium	Medium	PCD	CBN
MP	MM	R/L-F	
 (07,11)	 (07,11)	 (07,11)	 (07,11)

Order Number	Stock		Insert Number	Dimensions(mm)								Maximum Recommendation l/d Ratio	* 		
	R	L		DCON	LF	LDRED	WF	WF2	H	GAMF	DMIN		Clamp Screw	Wrench	
FSDQC1310R/L-07S	●	●	DCET	0702 \odot	10	150	20.5	7.6	2.6	9	8°	13	3.5	TS25	TKY08F
FSDQC1612R/L-07S	●	●	DCMT	0702 \odot	12	150	22.5	8.6	2.6	11	6°	16	4	TS25	TKY08F
FSDQC2016R/L-07S	●	●	DCMW	0702 \odot	16	180	22.5	10.6	2.6	15	5°	20	5	TS25	TKY08F
FSDQC2520R/L-11S [☆]	●	●	DCGT	0702 \odot	20	180	26	13.7	3.7	19	7°	25	5	TS43	TKY15F
			DCGW	11T3 \odot											

* Clamp Torque (N · m) : TS25=1.0, TS43=3.5

BORING BARS







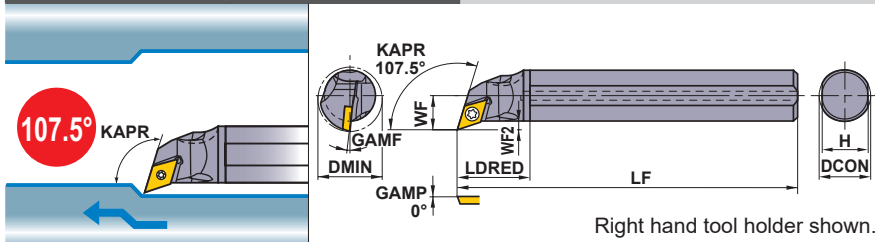

FSDQC

NEW

Steel shank with coolant hole

DC \odot inserts



Finish	Finish	Light	Light
FP	FM	LP	LM
 (07,11)	 (07,11)	 (07,11)	 (07,11)
Medium	Medium	PCD	CBN
MP	MM	R/L-F	
 (07,11)	 (07,11)	 (07,11)	 (07,11)

Order Number	Stock		Insert Number	Dimensions(mm)								Maximum Recommendation l/d Ratio	* 		
	R	L		DCON	LF	LDRED	WF	WF2	H	GAMF	DMIN		Clamp Screw	Wrench	
FSDQC1310R/L-07A	●	●	DCET	0702 \odot	10	150	20.5	7.6	2.6	9	8°	13	3.5	TS25	TKY08F
FSDQC1612R/L-07A	●	●	DCMT	0702 \odot	12	150	22.5	8.6	2.6	11	6°	16	4	TS25	TKY08F
FSDQC2016R/L-07A	●	●	DCMW	0702 \odot	16	180	22.5	10.6	2.6	15	5°	20	5	TS25	TKY08F
FSDQC2520R/L-11A [☆]	●	●	DCGT	0702 \odot	20	180	26	13.7	3.7	19	7°	25	5	TS43	TKY15F
			DCGW	11T3 \odot											

* Clamp Torque (N · m) : TS25=1.0, TS43=3.5

● = **NEW**

Note 1) The insert photos are only examples. The letters refer to the chip breaker and the dimension refers to the inscribed circle.

Note 2) Dimensions shown for insert corner RE 0.4. (Model of ☆ Mark is RE 0.8)

Note 3) When using insert with right and left hand chip breaker, please use left hand insert for right hand holder and right hand insert for left hand holder.

● : Inventory maintained in Japan.

DC \odot type inserts > A124–A129

CBN & PCD inserts > B044, B045, B060

FSDQC_E

Carbide shank with coolant hole **DC** inserts

107.5° KAPR

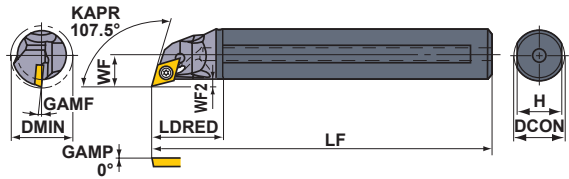

Finish	Finish	Light	Light
FP (07,11)	FM (07,11)	LP (07,11)	LM (07,11)
Medium MP (07,11)	Medium MM (07,11)	PCD R/L-F (07,11)	CBN (07,11)

Order Number	Stock		Insert Number	Dimensions(mm)								Maximum Recommendation I/d Ratio	*		
	R	L		DCON	LF	LDRED	WF	WF2	H	GAMP	DMIN		Clamp Screw	Wrench	
FSDQC1310R/L-07E	●	●	DCET DCMT DCMW DCGT DCGW	0702	10	162	18.4	7.6	2.6	9	8°	13	7.5	TS25	TKY08F
FSDQC1612R/L-07E	●	●		0702	12	182	20.2	8.6	2.6	11	6°	16	8	TS25	TKY08F
FSDQC2016R/L-07E	●	●		0702	16	222	24.2	10.6	2.6	15	5°	20	8	TS25	TKY08F
FSDQC2520R/L-11E ☆	●	●		11T3	20	254	28.0	13.7	3.7	19	7°	25	8	TS43	TKY15F

* Clamp Torque (N • m) : TS25=1.0, TS43=3.5

BORING BARS

DC type inserts > A124–A129
CBN & PCD inserts > B044, B045, B060

CUTTING CONDITIONS > E020
SPARE PARTS > P001
TECHNICAL DATA > Q001

BORING BARS

DIMPLE BAR

- Excellent vibration resistance due to light dimple head.
- Chip disposal is improved by having two channels for chip evacuation.
- A laser printed scale on the side for easy installation (Steel shank).
- l/d is 3 to 5 times the diameter (Carbide shank is 3 to 8 times the diameter).



FSWUB/P

WB○inserts, WP○inserts

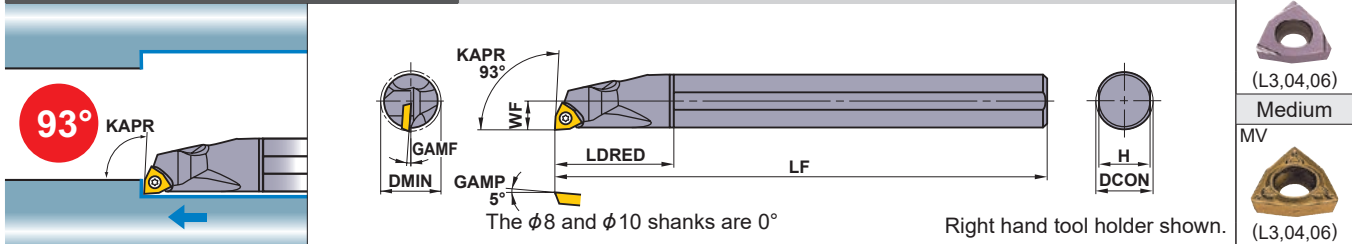

Finish
R/L-F-FS

(L3,04,06)

Medium
MV

(L3,04,06)

Order Number	Stock		Insert Number	Dimensions(mm)							Maximum Recommendation l/d Ratio	*		
	R	L		DCON	LF	LDRED	WF	H	GAMF	DMIN		Clamp Screw	Wrench	
FSWUB1008R/L-L3S ☆1	●	●	WBMT WBGT	L302	8	125	18	5	7.2	14°	10	3	TS2	TKY06F
FSWUB1210R/L-L3S ☆1	●	●		L302	10	150	22.5	6	9	11°	12	3.5	TS2	TKY06F
FSWUP1412R/L-04S	●	●	WPMT WPGT	0402	12	150	27	7	11	4°	14	4	TS253	TKY08F
FSWUP1816R/L-04S	●	●		0402	16	180	36	9	15	1°	18	5	TS253	TKY08F
FSWUP2220R/L-06S ☆2	●	●		0603	20	220	45	11	19	2°	22	5	TS4	TKY15F
FSWUP3025R/L-06S ☆2	●	●		0603	25	250	56.3	15	23.4	0°	30	5	TS4	TKY15F

* Clamp Torque (N · m) : TS2=0.6, TS253=1.0, TS4=3.5

BORING BARS

E

FSWUB/P

NEW

Steel shank with coolant hole

WB○inserts, WP○inserts

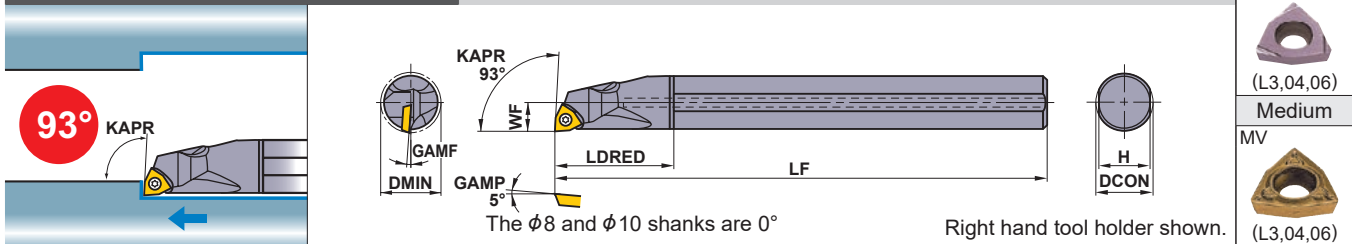

Finish
R/L-F-FS

(L3,04,06)

Medium
MV

(L3,04,06)

Order Number	Stock		Insert Number	Dimensions(mm)							Maximum Recommendation l/d Ratio	*		
	R	L		DCON	LF	LDRED	WF	H	GAMF	DMIN		Clamp Screw	Wrench	
FSWUB1008R/L-L3A ☆1	●	●	WBMT WBGT	L302	8	125	18	5	7.2	14°	10	3	TS2	TKY06F
FSWUB1210R/L-L3A ☆1	●	●		L302	10	150	22.5	6	9	11°	12	3.5	TS2	TKY06F
FSWUP1412R/L-04A	●	●	WPMT WPGT	0402	12	150	27	7	11	4°	14	4	TS253	TKY08F
FSWUP1816R/L-04A	●	●		0402	16	180	36	9	15	1°	18	5	TS253	TKY08F
FSWUP2220R/L-06A ☆2	●	●		0603	20	220	45	11	19	2°	22	5	TS4	TKY15F
FSWUP3025R/L-06A ☆2	●	●		0603	25	250	56.3	15	23.4	0°	30	5	TS4	TKY15F

* Clamp Torque (N · m) : TS2=0.6, TS253=1.0, TS4=3.5

● = **NEW**

Note 1) The insert photos are only examples. The letters refer to the chip breaker and the dimension refers to the inscribed circle.

Note 2) Dimensions shown for insert corner RE 0.4. (Model of ☆1 Mark is RE 0.2, Model of ☆2 Mark is RE 0.8)

Note 3) When using insert with right and left hand chip breaker, please use left hand insert for right hand holder and right hand insert for left hand holder.

● : Inventory maintained in Japan.

WB○ type inserts > A150
WP○ type inserts > A152
PCD inserts > B065

FSWUB/P_E

Carbide shank
with coolant hole

WB \odot inserts, WP \odot inserts

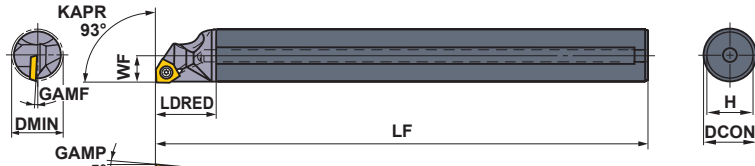
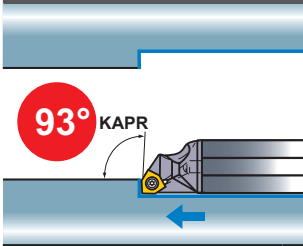

Finish
R/L-F-FS

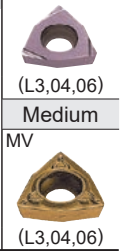

The $\phi 8$ and $\phi 10$ shanks are 0°

Right hand tool holder shown.



Order Number	Stock		Insert Number	Dimensions(mm)							Maximum Recommendation l/d Ratio	*  		
	R	L		DCON	LF	LDRED	WF	H	GAMF	DMIN		Clamp Screw	Wrench	
FSWUB1008R/L-L3E $\star 1$	●	●	WBMT WBG T	L302 \odot	8	140	13.8	5	7.2	14°	10	7	TS2	TKY06F
FSWUB1008R-L3E-2/3 $\star 1$	●	●		L302 \odot	8	90	13.8	5	7.2	14°	10	5	TS2	TKY06F
FSWUB1008R-L3E-1/2 $\star 1$	●	●		L302 \odot	8	70	13.8	5	7.2	14°	10	3	TS2	TKY06F
FSWUB1210R/L-L3E $\star 1$	●	●		L302 \odot	10	160	16.0	6	9	11°	12	7.5	TS2	TKY06F
FSWUB1210R-L3E-2/3 $\star 1$	●	●		L302 \odot	10	105	16.0	6	9	11°	12	5	TS2	TKY06F
FSWUB1210R-L3E-1/2 $\star 1$	●	●		L302 \odot	10	80	16.0	6	9	11°	12	3	TS2	TKY06F
FSWUP1412R/L-04E	●	●	WPMT WPG T	0402 \odot	12	180	17.8	7	11	4°	14	8	TS253	TKY08F
FSWUP1412R-04E-2/3	●	●		0402 \odot	12	120	17.8	7	11	4°	14	5	TS253	TKY08F
FSWUP1412R-04E-1/2	●	●		0402 \odot	12	90	17.8	7	11	4°	14	3	TS253	TKY08F
FSWUP1816R/L-04E	●	●		0402 \odot	16	220	21.8	9	15	1°	18	8	TS253	TKY08F
FSWUP1816R-04E-2/3	●	●		0402 \odot	16	145	21.8	9	15	1°	18	5	TS253	TKY08F
FSWUP1816R-04E-1/2	●	●		0402 \odot	16	110	21.8	9	15	1°	18	3	TS253	TKY08F
FSWUP2220R/L-06E $\star 2$	●	●	0603 \odot	20	250	24.0	11	19	2°	22	8	TS4	TKY15F	
FSWUP 2220R-06E-2/3 $\star 2$	●	●	0603 \odot	20	165	24.0	11	19	2°	22	5	TS4	TKY15F	
FSWUP 2220R-06E-1/2 $\star 2$	●	●	0603 \odot	20	125	24.0	11	19	2°	22	3	TS4	TKY15F	

* Clamp Torque (N · m) : TS2=0.6, TS253=1.0, TS4=3.5

BORING BARS

WB \odot type inserts > A150
WP \odot type inserts > A152
PCD inserts > B065

CUTTING CONDITIONS > E020
SPARE PARTS > P001
TECHNICAL DATA > Q001

BORING BARS

DIMPLE BAR

- Excellent vibration resistance due to light dimple head.
- Chip disposal is improved by having two channels for chip evacuation.
- A laser printed scale on the side for easy installation (Steel shank).
- l/d is 3 to 5 times the diameter (Carbide shank is 3 to 8 times the diameter).



FSVUB/C

VC[○]inserts, VB[○]inserts

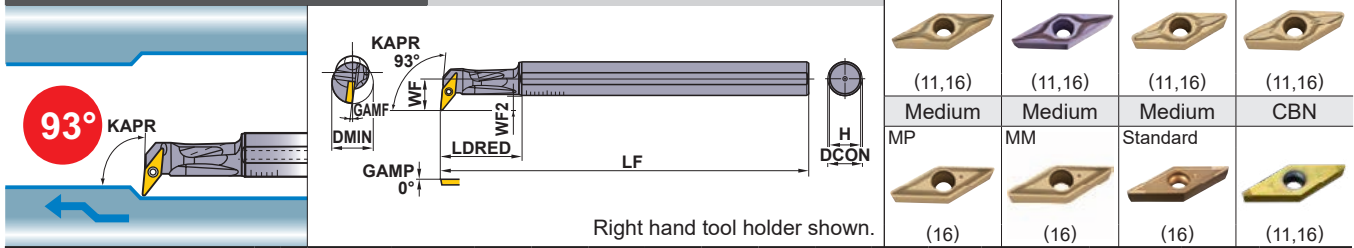

Order Number	Stock		Insert Number	Dimensions(mm)							DMIN	Maximum Recommendation l/d Ratio	Finish				
	R	L		DCON	LF	LDRED	WF	WF2	H	GAMF			FP	FM	LP	LM	
FSVUC1612R/L-08S	●	●	VCGT VCMT	0802	12	150	25	11	5.5	11	8°	16	4	—	—	TS202	TKY06F
FSVUB2016R/L-11S	●	●	VBMT	1103	16	180	32.5	15.5	8	15	8°	20	5	—	—	TS255	TKY08F
FSVUB2520R/L-11S	●	●	VBMT VBMW	1103	20	200	40.5	17.5	8	19	7°	25	5	—	—	TS255	TKY08F
FSVUB3425R/L-16S ^{☆2}	●	●	VBET VBGW	1604	25	220	50	20.5	8.5	23.4	13°	34	5	SPSVN32	BCP141	TS35D	TKY15F
FSVUB4032R/L-16S ^{☆2}	●	●	VBET VBGW	1604	32	250	84.0	27.5	12	30.4	9°	40	5	SPSVN32	BCP141	TS35D	TKY15F

* Clamp Torque (N · m) : TS202=0.6, TS255=1.0, TS35D=3.5

BORING BARS

E

FSVUB/C

NEW

Steel shank with coolant hole

VC[○]inserts, VB[○]inserts

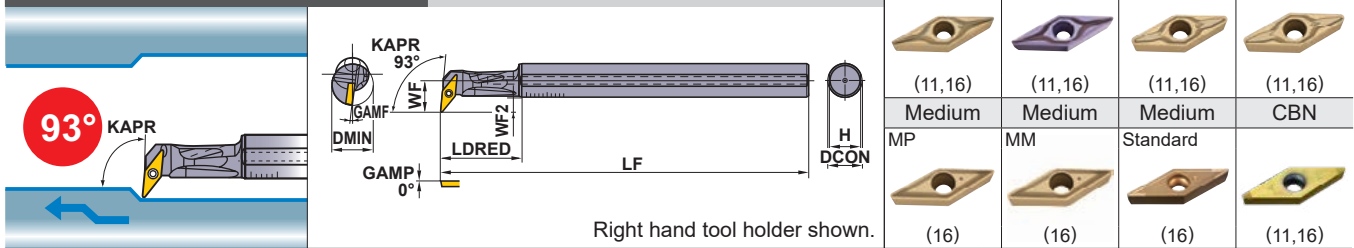

Order Number	Stock		Insert Number	Dimensions(mm)							DMIN	Maximum Recommendation l/d Ratio	Finish				
	R	L		DCON	LF	LDRED	WF	WF2	H	GAMF			FP	FM	LP	LM	
FSVUC1612R/L-08A	●	●	VCGT VCMT	0802	12	150	25	11	5.5	11	8°	16	4	—	—	TS202	TKY06F
FSVUB2016R/L-11A	●	●	VBMT	1103	16	180	32.5	15.5	8	15	8°	20	5	—	—	TS255	TKY08F
FSVUB2520R/L-11A	●	●	VBMT VBMW	1103	20	200	40.5	17.5	8	19	7°	25	5	—	—	TS255	TKY08F
FSVUB3425R/L-16A ^{☆2}	●	●	VBET VBGW	1604	25	220	50	20.5	8.5	23.4	13°	34	5	SPSVN32	BCP141	TS35D	TKY15F
FSVUB4032R/L-16A ^{☆2}	●	●	VBET VBGW	1604	32	250	84.0	27.5	12	30.4	9°	40	5	SPSVN32	BCP141	TS35D	TKY15F

* Clamp Torque (N · m) : TS202=0.6, TS255=1.0, TS35D=3.5

● = NEW

Note 1) The insert photos are only examples. The letters refer to the chip breaker and the dimension refers to the inscribed circle.

Note 2) Dimensions shown for insert corner RE 0.4. (Model of ☆1 Mark is RE 0.2, Model of ☆2 Mark is RE 0.8)

Note 3) When using insert with right and left hand chip breaker, please use left hand insert for right hand holder and right hand insert for left hand holder.

● : Inventory maintained in Japan.



VB [○] type inserts	> A142—A144
VC [○] type inserts	> A145—A147
CBN & PCD inserts	> B049, B064

FSVPB/C

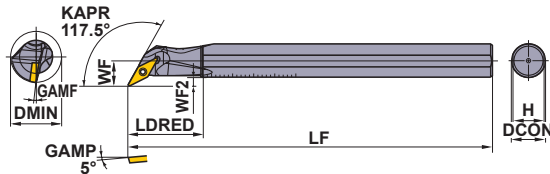
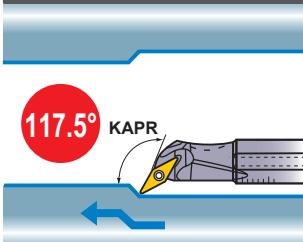
VC $\odot\odot$ inserts, VB $\odot\odot$ inserts



Right hand tool holder shown.

Finish	Finish	Light	Light
FP	FM	LP	LM
			
(11,16)	(11,16)	(11,16)	(11,16)
Medium	Medium	Medium	CBN
MP	MM	Standard	
			
(16)	(16)	(16)	(11,16)

Order Number	Stock		Insert Number	Dimensions(mm)								Maximum Recommendation l/d Ratio	Tools				
	R	L		DCON	LF	LDRED	WF	WF2	H	GAMF	DMIN		Shim	Shim Pin	Clamp Screw*	Wrench	
FSVPC1610R/L-08S	●	●	VCGT VCMT	0802 $\odot\odot$	10	150	25	8	3	9	8°	16	3.5	—	—	TS202	TKY06F
FSVPB2012R/L-11S	●	●		1103 $\odot\odot$	12	150	28	10	4.5	11	8°	20	4	—	—	TS255	TKY08F
FSVPB2516R/L-11S	●	●	VBMT	1103 $\odot\odot$	16	180	35	12.5	5	15	5°	25	5	—	—	TS255	TKY08F
FSVPB3020R/L-11S	●	●	VBMW VBET	1103 $\odot\odot$	20	200	40	15	5	19	5°	30	5	—	—	TS255	TKY08F
FSVPB3425R/L-16S ^{☆2}	●	●	VBGW	1604 $\odot\odot$	25	220	50	17	5	23.4	13°	34	5	SPSVN32	BCP141	TS35D	TKY15F
FSVPB4032R/L-16S ^{☆2}	●	●		1604 $\odot\odot$	32	250	55	22	6.5	30.4	9°	40	5	SPSVN32	BCP141	TS35D	TKY15F

* Clamp Torque (N · m) : TS202=0.6, TS255=1.0, TS35D=3.5

FSVPB/C







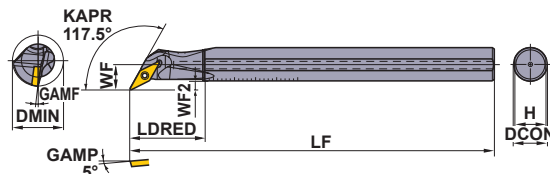
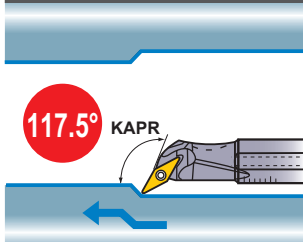

NEW

Steel shank
with coolant hole

VC $\odot\odot$ inserts, VB $\odot\odot$ inserts



Right hand tool holder shown.

Finish	Finish	Light	Light
FP	FM	LP	LM
			
(11,16)	(11,16)	(11,16)	(11,16)
Medium	Medium	Medium	CBN
MP	MM	Standard	
			
(16)	(16)	(16)	(11,16)

Order Number	Stock		Insert Number	Dimensions(mm)								Maximum Recommendation l/d Ratio	Tools				
	R	L		DCON	LF	LDRED	WF	WF2	H	GAMF	DMIN		Shim	Shim Pin	Clamp Screw*	Wrench	
FSVPC1610R/L-08A	●	●	VCGT VCMT	0802 $\odot\odot$	10	150	25	8	3	9	8°	16	3.5	—	—	TS202	TKY06F
FSVPB2012R/L-11A	●	●		1103 $\odot\odot$	12	150	28	10	4.5	11	8°	20	4	—	—	TS255	TKY08F
FSVPB2516R/L-11A	●	●	VBMT	1103 $\odot\odot$	16	180	35	12.5	5	15	5°	25	5	—	—	TS255	TKY08F
FSVPB3425R/L-16A ^{☆2}	●	●	VBMW VBET	1604 $\odot\odot$	25	220	50	17	5	23.4	13°	34	5	SPSVN32	BCP141	TS35D	TKY15F
FSVPB4032R/L-16A ^{☆2}	●	●	VBGW	1604 $\odot\odot$	32	250	55	22	6.5	30.4	9°	40	5	SPSVN32	BCP141	TS35D	TKY15F

* Clamp Torque (N · m) : TS202=0.6, TS255=1.0, TS35D=3.5

● = **NEW**

VB $\odot\odot$ type inserts	> A142—A144
VC $\odot\odot$ type inserts	> A145—A147
CBN & PCD inserts	> B049, B064

CUTTING CONDITIONS	> E020
SPARE PARTS	> P001
TECHNICAL DATA	> Q001

BORING BARS

DIMPLE BAR

- Excellent vibration resistance due to light dimple head.
- Chip disposal is improved by having two channels for chip evacuation.
- A laser printed scale on the side for easy installation (Steel shank).
- l/d is 3 to 5 times the diameter.



FSVJB/C

VC \odot inserts, VB \odot inserts

142°

Finish	Finish	Light	Light
FP	FM	LP	LM
(11)	(11)	(11)	(11)
Medium			
MV			
(08,11)			

Right hand tool holder shown.

Order Number	Stock		Insert Number	Dimensions(mm)							Maximum Recommendation l/d Ratio	*		
	R	L		DCON	LF	LDRED	WF	H	GAMF	DMIN		Clamp Screw	Wrench	
FSVJC1612R/L-08S ☆	●	●	VCGT VCMT	0802 \odot	12	150	26	2	11	5°	16	4	TS202	TKY06F
FSVJC2016R/L-08S ☆	●	●		0802 \odot	16	180	36	2	15	5°	20	5	TS202	TKY06F
FSVJB2520R/L-11S ☆	●	●	VBMT VBMW VBET VBGW	1103 \odot	20	200	37.5	2	19	5°	25	5	TS255	TKY08F
FSVJB3025R/L-11S ☆	●	●		1103 \odot	25	250	45	3.5	23.4	5°	30	5	TS255	TKY08F

* Clamp Torque (N · m) : TS202=0.6, TS255=1.0

RECOMMENDED CUTTING CONDITIONS

Workpiece Material	Cutting Mode	Breaker	Recom- mendation	Grade	Cutting Speed (m/min)	l/d ≤ 3 (Steel shank) l/d ≤ 6 (Carbide shank)		l/d = 4-5 (Steel shank) l/d = 7-8 (Carbide shank)	
						Feed (mm/rev)	Depth of Cut (mm)	Feed (mm/rev)	Depth of Cut (mm)
P Mild Steel ≤180HB	Finish	FP	①	NX2525	170 (120-220)	0.10 (0.05-0.15)	-0.5	0.10 (0.05-0.15)	-0.5
			②	MP3025	150 (100-200)	0.20 (0.10-0.25)	-1.0	0.15 (0.05-0.20)	-1.0
	Light	LP	①	NX2525	160 (110-210)	0.20 (0.10-0.25)	-1.0	0.15 (0.05-0.20)	-1.0
			②	MP3025	140 (90-190)	0.25 (0.15-0.35)	-2.0	0.20 (0.15-0.25)	-1.5
	Medium	MP	①	NX2525	150 (100-200)	0.25 (0.15-0.35)	-2.0	0.20 (0.15-0.25)	-1.5
			②	MP3025	100 (60-150)	0.25 (0.15-0.35)	-2.0	0.20 (0.15-0.25)	-1.5
M Stainless Steel ≤200HB	Finish	FP	①	MC6015	140 (90-190)	0.10 (0.05-0.15)	-0.5	0.10 (0.05-0.15)	-0.5
			②	NX2525	130 (80-180)	0.10 (0.05-0.15)	-0.5	0.10 (0.05-0.15)	-0.5
	Light	LP	①	MC6025	140 (90-190)	0.20 (0.10-0.25)	-1.0	0.15 (0.05-0.20)	-1.0
			②	MP3025	110 (60-160)	0.20 (0.10-0.25)	-1.0	0.15 (0.05-0.20)	-1.0
	Medium	MP	①	MC6025	130 (80-180)	0.25 (0.15-0.35)	-2.0	0.20 (0.15-0.25)	-1.5
			②	MP3025	120 (80-160)	0.20 (0.15-0.25)	-2.0	0.20 (0.15-0.25)	-1.0
K Gray Cast Iron Tensile Strength ≤350MPa	Finish	F, FS	①	HTi10	130 (90-160)	0.15 (0.10-0.20)	-0.5	0.15 (0.10-0.20)	-0.5
			②	MC5015	90 (60-120)	0.20 (0.15-0.25)	-2.0	0.20 (0.15-0.25)	-1.5
N Aluminium Alloy	Finish	F, FS	①	HTi10	300 (200-400)	0.10 (0.05-0.15)	-0.5	0.10 (0.05-0.15)	-0.5
			②	MD220	200 (150-250)	0.10 (0.05-0.15)	-2.0	0.10 (0.05-0.15)	-1.0
H Hardened Steel 35-65HRC	Finish	Flat Top	①	MB8120	100 (80-200)	0.10 (0.05-0.15)	-0.15	0.10 (0.05-0.15)	-0.1

When vibrations occur, reduce cutting speed by 30%.

The depth of cut needs to be less than the corner diameter when using the FSVJ type.

Note 1) The insert photos are only examples. The letters refer to the chip breaker and the dimension refers to the inscribed circle.

Note 2) Dimensions shown for insert corner RE 0.4. (Model of ☆ Mark is RE 0.8)

Note 3) When using insert with right and left hand chip breaker, please use left hand insert for right hand holder and right hand insert for left hand holder.

● : Inventory maintained in Japan.

VB \odot type inserts > A142-A144
VC \odot type inserts > A145-A147
CBN & PCD inserts > B049, B064

DOUBLE CLAMP DIMPLE BAR

- Economical negative insert.
- Single action type.
- Excellent vibration resistance due to a light dimple head. (With coolant hole.)
- l/d is 3 to 4 times the diameter.

A○○○-DCLN		With coolant hole		CN○○inserts		Finish	Light	Light	Light								
				FP	SA	LP	LM										
				(12)	(12)	(12)	(12)										
				Medium	Medium	Stainless	CBN/PCD										
				MP	Standard	MM		(12)	(12)	(12)	(12)						
Right hand tool holder shown.																	
Order Number	Stock		Insert Number	Dimensions(mm)													
	R	L		DCON	LF	LDRED	WF	H	GAMF	DMIN	Shim	Shim Pin	Clamp Bridge	Spring	Clamp Screw	Wrench	
A25R-DCLNR/L12	●	●	CN○○A CN○○G CN○○M	1204○○	25	200	40	17	23	13°	32	LLSCP42	LLP14	DCK2613	DCS1	DC0621T	TKY20F
A32S-DCLNR/L12	●	●		1204○○	32	250	50	22	30	13°	40	LLSCN42	LLP14	DCK2613	DCS1	DC0621T	TKY20F
A40T-DCLNR/L12	●	●		1204○○	40	300	63	27	37	10°	50	LLSCN42	LLP14	DCK2613	DCS1	DC0621T	TKY20F

* Clamp Torque (N · m) : DC0621T=5.0

A○○○-DDUN		With coolant hole		DN○○inserts		Finish	Light	Medium	Medium								
				FP	LP	MP	MH										
				(15)	(15)	(15)	(15)										
				Medium	Stainless	G class	CBN/PCD										
				Standard	MM	R/L		(15)	(15)	(15)	(15)						
Right hand tool holder shown.																	
Order Number	Stock		Insert Number	Dimensions(mm)													
	R	L		DCON	LF	LDRED	WF	H	GAMF	DMIN	Shim	Shim Pin	Clamp Bridge	Spring	Clamp Screw	Wrench	
A25R-DDUNR/L15	●	●	DN○○A DN○○G DN○○M	1504○○	25	200	40	17	23	13°	35	LLSDP42	LLP14	DCK2613	DCS1	DC0621T	TKY20F
A32S-DDUNR/L15	●	●		1504○○	32	250	50	22	30	13°	40	LLSDN42	LLP14	DCK2613	DCS1	DC0621T	TKY20F
A40T-DDUNR/L15	●	●		1504○○	40	300	63	27	37	10°	50	LLSDN42	LLP14	DCK2613	DCS1	DC0621T	TKY20F

* Clamp Torque (N · m) : DC0621T=5.0

RECOMMENDED CUTTING CONDITIONS

Workpiece Material	Hardness	Cutting Mode	l/d ≤ 3			l/d = 3-4		
			Cutting Speed (m/min)	Feed (mm/rev)	Depth of Cut (mm)	Cutting Speed (m/min)	Feed (mm/rev)	Depth of Cut (mm)
P Carbon Steel Alloy Steel	180-350HB	Medium	110 (80-140)	0.25 (0.1-0.4)	-5.0	110 (80-140)	0.2 (0.1-0.3)	-4.0
M Stainless Steel	≤200HB	Medium	80 (60-100)	0.2 (0.1-0.3)	-4.0	70 (50-100)	0.15 (0.1-0.25)	-3.0
K Gray Cast Iron	Tensile Strength ≤350MPa	Medium	80 (60-100)	0.25 (0.1-0.4)	-5.0	80 (60-100)	0.2 (0.1-0.3)	-4.0











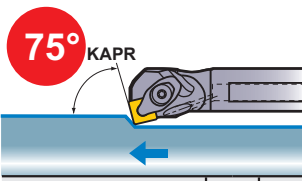
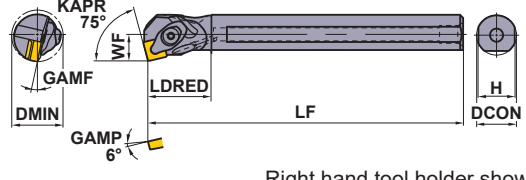
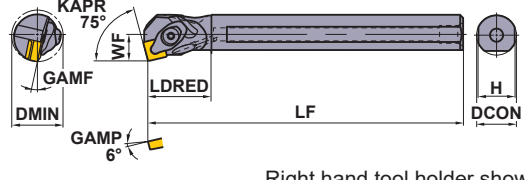
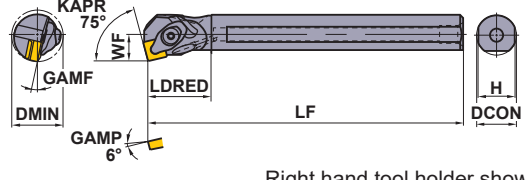
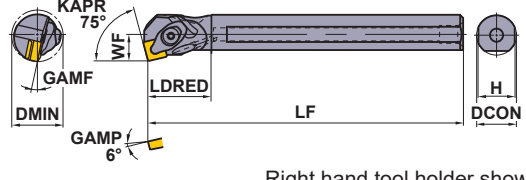
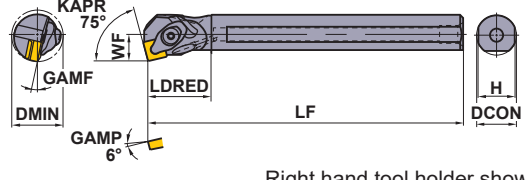
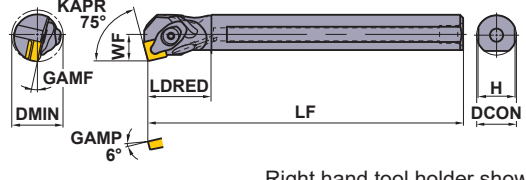
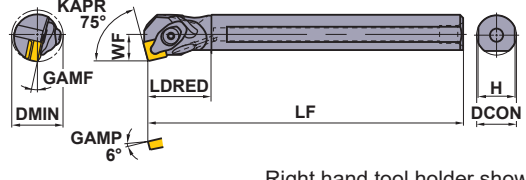
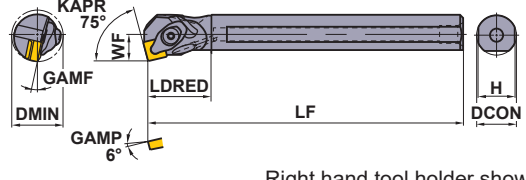

CN○○ type inserts > A074-A080
 DN○○ type inserts > A081-A087
 CBN & PCD inserts > B022-B030, B055

SPARE PARTS > P001
 TECHNICAL DATA > Q001

BORING BARS









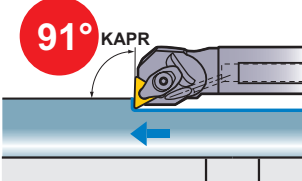
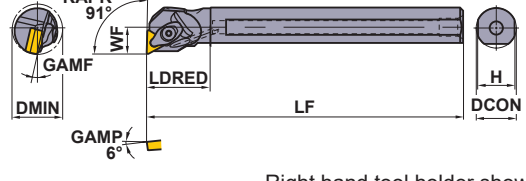
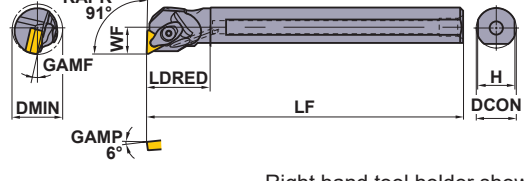
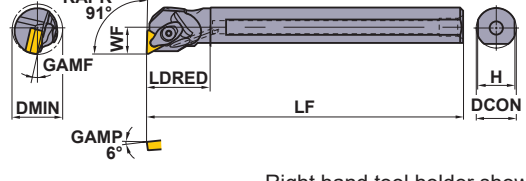
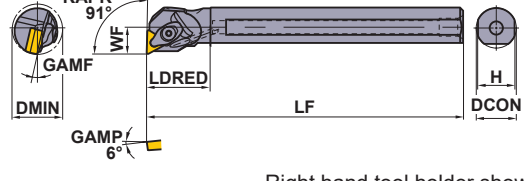
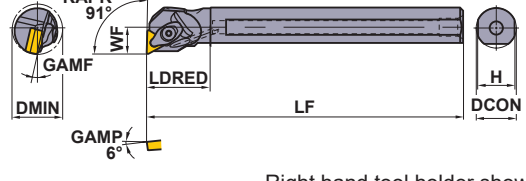
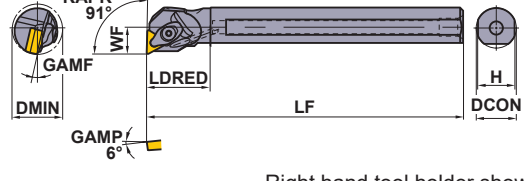
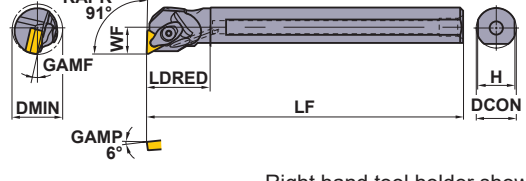
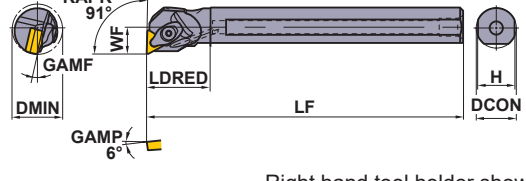

DOUBLE CLAMP DIMPLE BAR

- Economical negative insert.
- Single action type.
- Excellent vibration resistance due to a light dimple head. (With coolant hole.)
- l/d is 3 to 4 times the diameter.

A○○○-DSKN		With coolant hole		SN○○inserts						Finish	Light	Medium	Medium				
									FP	LP	MP	MH					
									(12)	(12)	(12)	(12)					
Right hand tool holder shown.									Medium	Stainless	G class	CBN/PCD					
									Standard	MM	R/L						
									(12)	(12)	(12)	(12)					
Order Number	Stock		Insert Number	Dimensions(mm)						 Shim	 Shim Pin	 Clamp Bridge	 Spring	 Clamp Screw *	 Wrench		
	R	L		DCON	LF	LDRED	WF	H	GAMF							DMIN	
A25R-DSKNR/L12	●	●	 SNMA  SNMG  SNMM  SNGA  SNGG	1204	25	200	40	17	23	13°	32	LLSSP42	LLP14	DCK2613	DCS1	DC0621T	TKY20F
A32S-DSKNR/L12	●	●		1204	32	250	50	22	30	13°	40	LLSSN42	LLP14	DCK2613	DCS1	DC0621T	TKY20F

* Clamp Torque (N · m) : DC0621T=5.0

BORING BARS

A○○○-DTFN		With coolant hole		TN○○inserts						Finish	Light	Medium	Medium				
									FP	LP	MP	MH					
									(16)	(16)	(16)	(16)					
Right hand tool holder shown.									Medium	Stainless	G class	CBN/PCD					
									Standard	MM	R/L						
									(16)	(16)	(16)	(16)					
Order Number	Stock		Insert Number	Dimensions(mm)						 Shim	 Shim Pin	 Clamp Bridge	 Spring	 Clamp Screw *	 Wrench		
	R	L		DCON	LF	LDRED	WF	H	GAMF							DMIN	
A25R-DTFNR/L16	●	●	 TNA  TNG  TNM	1604	25	200	40	17	23	13°	32	LLSTP32	LLP23	DCK2211	DCS2	DC0520T	TKY15F
A32S-DTFNR/L16	●	●		1604	32	250	50	22	30	13°	40	LLSTN32	LLP23	DCK2211	DCS2	DC0520T	TKY15F

* Clamp Torque (N · m) : DC0520T=3.5

Note 1) The insert photos are only examples. The letters refer to the chip breaker and the dimension refers to the inscribed circle.

Note 2) Dimensions shown for insert corner RE 0.8.

Note 3) When using insert with right and left hand chip breaker, please use left hand insert for right hand holder and right hand insert for left hand holder.

● : Inventory maintained in Japan.

SN○○ type inserts	> A089 – A094
TN○○ type inserts	> A095 – A101
CBN & PCD inserts	> B031 – B034, B056

A $\circ\circ\circ$ -DVUN With coolant hole VN $\circ\circ$ inserts										Finish	Light	Medium	Medium				
										FP	LP	MP	MH				
										(16)	(16)	(16)	(16)				
										Medium	Stainless	G class	CBN/PCD				
										Standard	MM	R/L					
										(16)	(16)	(16)	(16)				
Order Number	Stock		Insert Number	Dimensions(mm)						Shim	Shim Pin	Clamp Bridge	Spring	Clamp Screw *	Wrench		
	R	L		DCON	LF	LDRED	WF	H	GAMF							DMIN	
A40T-DVUNR/L16	●	●	VN-A VN-G VN-M	1604	40	300	63	27	37	9°	50	DCSVN32	LLP13	DCK3113	DCS2	DC0520T	TKY15F

* Clamp Torque (N · m) : DC0520T=3.5

A $\circ\circ\circ$ -DWLN With coolant hole WN $\circ\circ$ inserts										Finish	Light	Medium	Medium				
										FP	LP	MP	MK				
										(08)	(06, 08)	(06,08)	(08)				
										Medium	Medium - Rough	Stainless					
										Standard	RP	MM					
										(08)	(08)	(06,08)					
Order Number	Stock		Insert Number	Dimensions(mm)						Shim	Shim Pin	Clamp Bridge	Spring	Clamp Screw *	Wrench		
	R	L		DCON	LF	LDRED	WF	H	GAMF							DMIN	
A25R-DWLN R/L06	●	●	WNMA WNMG	0604	25	200	40	17	23	13°	35	LLSWP32	LLP23	DCK2211	DCS2	DC0520T	TKY15F
A25R-DWLN R/L08	●	●	WNMA	0804	25	200	40	17	23	13°	35	LLSWP42	LLP14	DCK2613	DCS1	DC0621T	TKY20F
A32S-DWLN R/L08	●	●	WNMA WNMG	0804	32	250	50	22	30	13°	40	LLSWN42	LLP14	DCK2613	DCS1	DC0621T	TKY20F
A40T-DWLN R/L08	●	●	WNGA	0804	40	300	63	27	37	10°	50	LLSWN42	LLP14	DCK2613	DCS1	DC0621T	TKY20F

* Clamp Torque (N · m) : DC0520T=3.5, DC0621T=5.0

RECOMMENDED CUTTING CONDITIONS

Workpiece Material	Hardness	Cutting Mode	l/d ≤ 3			l/d = 3-4		
			Cutting Speed (m/min)	Feed (mm/rev)	Depth of Cut (mm)	Cutting Speed (m/min)	Feed (mm/rev)	Depth of Cut (mm)
P Carbon Steel Alloy Steel	180-350HB	Medium	110 (80-140)	0.25 (0.1-0.4)	-5.0	110 (80-140)	0.2 (0.1-0.3)	-4.0
M Stainless Steel	≤200HB	Medium	80 (60-100)	0.2 (0.1-0.3)	-4.0	70 (50-100)	0.15 (0.1-0.25)	-3.0
K Gray Cast Iron	Tensile Strength ≤350MPa	Medium	80 (60-100)	0.25 (0.1-0.4)	-5.0	80 (60-100)	0.2 (0.1-0.3)	-4.0

VN $\circ\circ$ type inserts > A102-A105
 WN $\circ\circ$ type inserts > A106-A110
 CBN & PCD inserts > B035-B037, B057

SPARE PARTS > P001
 TECHNICAL DATA > Q001

BORING BARS

MICRO-DEX BORING BARS

- The minimum cutting diameter is from $\phi 5$.
- 7° positive insert, carbide shank type.
- Easy-to-use tool geometries.
- Suitable for small workpieces.
- l/d is 5 times the diameter.



C SCLC

Carbide shank

CC inserts

Finish L-F

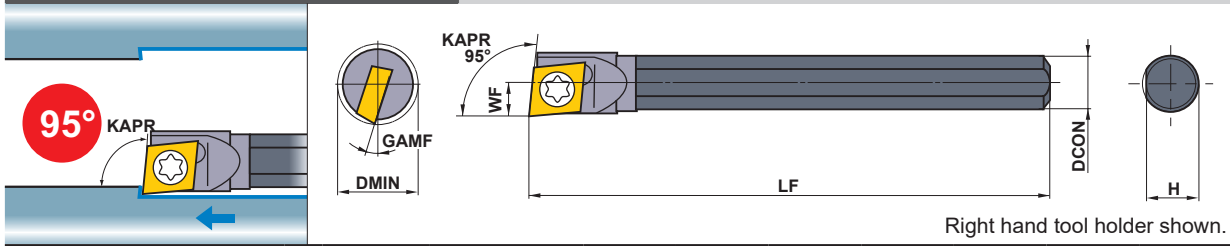

Right hand tool holder shown.

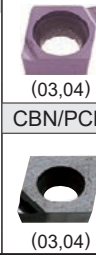

Order Number	Stock	Insert Number	Dimensions(mm)							*2	Wrench
			DCON	LF	WF	H	GAMF	DMIN			
C04GSCLCR03	●	*1 CCGT	4	90	2.5	3.7	15°	5	TS16	TKY06F	
C05HSCLCR03	●	CCGT	5	100	3.0	4.7	13°	6	TS16	TKY06F	
C06JSCLCR04	●	CCGW	6	110	3.5	5.7	13°	7	TS21	TKY06F	
C07KSCLCR04	●	CCMW	7	125	4.0	6.7	11°	8	TS21	TKY06F	

*1 Diameter of inscribed circle is special. (For SCLC type)

*2 Clamp Torque (N · m) : TS16=0.6, TS21=0.6

BORING BARS

E

C SWUB

Carbide shank

WB inserts

Finish L-F

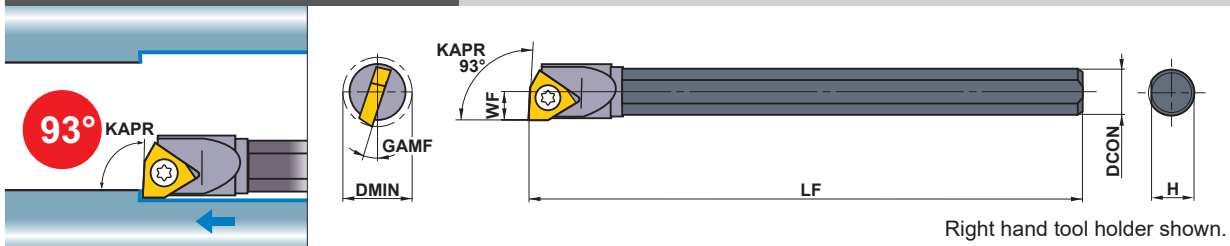

Right hand tool holder shown.

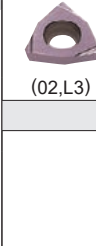

Order Number	Stock	Insert Number	Dimensions(mm)							*2	Wrench
			DCON	LF	WF	H	GAMF	DMIN			
C05HSWUBR02	●	WBGT	5	100	3.0	4.7	15°	6	TS21	TKY06F	
C06JSWUBR02	●	WBMT	6	110	3.5	5.7	13°	7	TS2C	TKY06F	
C07KSWUBR03	●	L302	7	125	4.0	6.7	15°	8	TS2	TKY06F	

* Clamp Torque (N · m) : TS21=0.6, TS2C=0.6, TS2=0.6

Note 1) The insert photos are only examples. The letters refer to the chip breaker and the dimension refers to the inscribed circle.

Note 2) Dimensions shown for insert corner RE 0.2.

Note 3) When using insert with right and left hand chip breaker, please use left hand insert for right hand holder and right hand insert for left hand holder.

● : Inventory maintained in Japan.

CCGT type inserts	> A115
WBGT type inserts	> A150
CBN & PCD inserts	> B041, B059

COSTUC			Carbide shank						TCGT inserts		Finish		
									 (06)		R/L-F		
Order Number			Insert Number		Dimensions(mm)						*		
C07KSTUCR06			TCGT 0601		DCON	LF	WF	WF2	H	GAMF	DMIN	Clamp Screw	Wrench
					7	125	4.0	0.35	6.7	12°	8	TS2C	TKY06F

* Clamp Torque (N · m) : TS2C=0.6

E

BORING BARS

RECOMMENDED CUTTING CONDITIONS

	Workpiece Material	Grade	Cutting Speed (m/min)	Feed (mm/rev)	Depth of Cut (mm)	l/d
P	Carbon Steel, Alloy Steel 180–350HB	NX2525	80 (40–120)	0.03 (0.01–0.05)	0.2 (0.1–0.3)	3–5
M	Stainless Steel ≤200HB	VP15TF	80 (40–120)	0.03 (0.01–0.05)	0.2 (0.1–0.3)	3–5
K	Gray Cast Iron ≤350MPa	VP15TF	80 (40–120)	0.03 (0.01–0.05)	0.2 (0.1–0.3)	3–5
N	Non-Ferrous Material	VP15TF	120 (80–160)	0.05 (0.01–0.08)	0.4 (0.1–0.6)	3–5
		MD220	120 (80–160)	0.05 (0.01–0.08)	0.4 (0.1–0.6)	3–5
H	Hardened Steel 35–65HRC	MB8110	80 (40–120)	0.03 (0.01–0.05)	0.1 (0.03–0.2)	3–5

TCGT type inserts > A135
 SPARE PARTS > P001
 TECHNICAL DATA > Q001

E025

BORING BARS

MICRO-DEX BORING BARS



STANDARD HOLDER

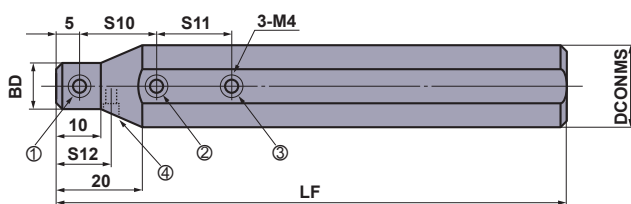
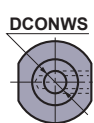

RBH2200N has a temporary set screw for different machine specifications.
(Represented by number 4)

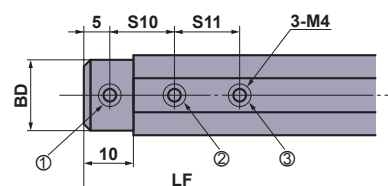

RBH15800N, RBH1600N,
RBH19000N

BORING BARS

Order Number	Stock	Dimensions(mm)							MICRO-DEX	*Clamp Screw				Wrench	Torque (N·m)
		DCONMS	DCONWS	BD	LF	S10	S11	S12		①	②	③	④		
RBH15840N	●	15.875	4	15	100	15	15	—	C04GS	A	A	A	—	HKY20F	2.0
RBH15850N	●	15.875	5	15	100	15	15	—	C05HS	A	A	A	—	HKY20F	2.0
RBH15860N	●	15.875	6	15	100	15	15	—	C06JS	A	A	A	—	HKY20F	2.0
RBH15870N	●	15.875	7	15	100	20	20	—	C07KS	A	A	A	—	HKY20F	2.0
RBH1640N	●	16	4	15	100	15	15	—	C04GS	A	A	A	—	HKY20F	2.0
RBH1650N	●	16	5	15	100	15	15	—	C05HS	A	A	A	—	HKY20F	2.0
RBH1660N	●	16	6	15	100	15	15	—	C06JS	A	A	A	—	HKY20F	2.0
RBH1670N	●	16	7	15	100	20	20	—	C07KS	A	A	A	—	HKY20F	2.0
*2 RBH19040N	●	19.05	4	18	125	15	15	—	C04GS	B	B	B	—	HKY20F	2.0
*2 RBH19050N	●	19.05	5	18	125	15	15	—	C05HS	B	B	B	—	HKY20F	2.0
*2 RBH19060N	●	19.05	6	18	125	15	15	—	C06JS	B	B	B	—	HKY20F	2.0
*2 RBH19070N	●	19.05	7	18	125	20	20	—	C07KS	B	B	B	—	HKY20F	2.0
RBH2040N	●	20	4	13	125	15	15	—	C04GS	A	B	B	—	HKY20F	2.0
RBH2050N	●	20	5	14	125	15	15	—	C05HS	A	B	B	—	HKY20F	2.0
RBH2060N	●	20	6	15	125	15	15	—	C06JS	A	B	B	—	HKY20F	2.0
RBH2070N	●	20	7	16	125	20	20	—	C07KS	A	B	B	—	HKY20F	2.0
RBH2240N	●	22	4	13	125	15	15	12.5	C04GS	A	B	B	A	HKY20F	2.0
RBH2250N	●	22	5	14	125	15	15	12.5	C05HS	A	B	B	A	HKY20F	2.0
RBH2260N	●	22	6	15	125	15	15	15	C06JS	A	B	B	A	HKY20F	2.0
RBH2270N	●	22	7	16	125	20	20	15	C07KS	A	B	B	A	HKY20F	2.0
RBH2540N	●	25	4	13	150	15	15	—	C04GS	A	C	C	—	HKY20F	2.0
RBH2550N	●	25	5	14	150	15	15	—	C05HS	A	C	C	—	HKY20F	2.0
RBH2560N	●	25	6	15	150	15	15	—	C06JS	A	C	C	—	HKY20F	2.0
RBH2570N	●	25	7	16	150	20	20	—	C07KS	A	C	C	—	HKY20F	2.0
RBH25440N	●	25.4	4	13	150	15	15	—	C04GS	A	C	C	—	HKY20F	2.0
RBH25450N	●	25.4	5	14	150	15	15	—	C05HS	A	C	C	—	HKY20F	2.0
RBH25460N	●	25.4	6	15	150	15	15	—	C06JS	A	C	C	—	HKY20F	2.0
RBH25470N	●	25.4	7	16	150	20	20	—	C07KS	A	C	C	—	HKY20F	2.0

*1 Order number of clamp screw A=HSS04004, B=HSS04006, C=HSS04008

*2 Revised order number.

Conventional Order Number	Revised Order Number
RBH1940N	RBH19040N
RBH1950N	RBH19050N
RBH1960N	RBH19060N
RBH1970N	RBH19070N

● : Inventory maintained in Japan.

(MICRO-MINI TWIN is available in 1 piece in one pack.)

MICRO-MINI TWIN



CB

For internal machining

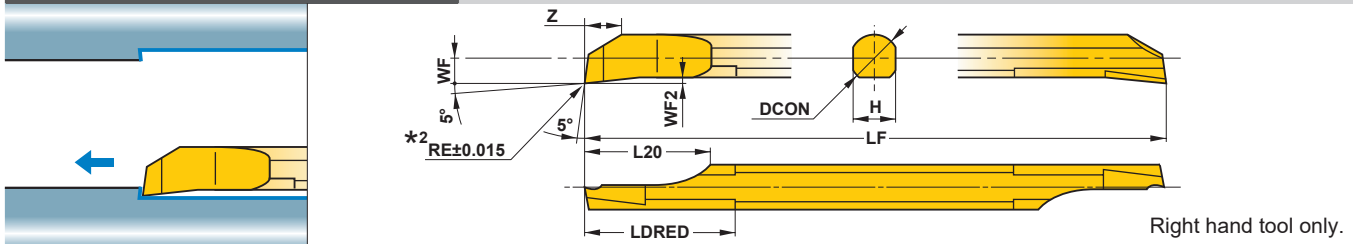

Order Number	Stock		Breaker	Dimensions(mm)										
	Micro-Grain	Coated		DMIN*1		RE	DCON	LF	L20	LDRED	WF	WF2	H	Z
	TF15	VP15TF		l/d ≤ 3	l/d > 3									
CB02RS	●	●	without	2.2	3.6	0.05	2	50	5	6	1	0.25	1.8	1.4
CB02RS-B	●	●	with	2.2	3.9	0.05	2	50	5	6	1	0.25	1.8	1.4
CB02RS-01	●	●	without	2.2	3.6	0.1	2	50	5	6	1	0.25	1.8	1.4
CB02RS-01B	●	●	with	2.2	4.2	0.1	2	50	5	6	1	0.25	1.8	1.4
CB02RS-02	●	●	without	2.2	3.6	0.2	2	50	5	6	1	0.25	1.8	1.4
CB02RS-02B	●	●	with	2.2	4.9	0.2	2	50	5	6	1	0.25	1.8	1.4
CB03RS	●	●	without	3.2	4.2	0.05	3	50	7.5	9	1.5	0.35	2.7	2.3
CB03RS-B	●	●	with	3.2	4.4	0.05	3	50	7.5	9	1.5	0.35	2.7	2.3
CB03RS-01	●	●	without	3.2	4.2	0.1	3	50	7.5	9	1.5	0.35	2.7	2.3
CB03RS-01B	●	●	with	3.2	4.5	0.1	3	50	7.5	9	1.5	0.35	2.7	2.3
CB03RS-02	●	●	without	3.2	4.2	0.2	3	50	7.5	9	1.5	0.35	2.7	2.3
CB03RS-02B	●	●	with	3.2	4.8	0.2	3	50	7.5	9	1.5	0.35	2.7	2.3
CB04RS	●	●	without	4.2	5.1	0.05	4	60	10	12	2	0.45	3.6	3.1
CB04RS-B	●	●	with	4.2	5.2	0.05	4	60	10	12	2	0.45	3.6	3.1
CB04RS-01	●	●	without	4.2	5.1	0.1	4	60	10	12	2	0.45	3.6	3.1
CB04RS-01B	●	●	with	4.2	5.3	0.1	4	60	10	12	2	0.45	3.6	3.1
CB04RS-02	●	●	without	4.2	5.1	0.2	4	60	10	12	2	0.45	3.6	3.1
CB04RS-02B	●	●	with	4.2	5.5	0.2	4	60	10	12	2	0.45	3.6	3.1
CB05RS	●	●	without	5.2	6.0	0.05	5	70	12.5	15	2.5	0.55	4.5	3.9
CB05RS-B	●	●	with	5.2	6.1	0.05	5	70	12.5	15	2.5	0.55	4.5	3.9
CB05RS-02	●	●	without	5.2	6.0	0.2	5	70	12.5	15	2.5	0.55	4.5	3.9
CB05RS-02B	●	●	with	5.2	6.4	0.2	5	70	12.5	15	2.5	0.55	4.5	3.9
CB06RS	●	●	without	6.2	7.2	0.05	6	75	12.5	18	3	0.65	5.4	4.7
CB06RS-B	●	●	with	6.2	7.3	0.05	6	75	12.5	18	3	0.65	5.4	4.7
CB06RS-02	●	●	without	6.2	7.2	0.2	6	75	12.5	18	3	0.65	5.4	4.7
CB06RS-02B	●	●	with	6.2	7.8	0.2	6	75	12.5	18	3	0.65	5.4	4.7
CB07RS	●	●	without	7.2	8.6	0.05	7	85	12.5	21	3.5	0.75	6.3	5.5
CB07RS-B	●	●	with	7.2	8.8	0.05	7	85	12.5	21	3.5	0.75	6.3	5.5
CB07RS-02	●	●	without	7.2	8.6	0.2	7	85	12.5	21	3.5	0.75	6.3	5.5
CB07RS-02B	●	●	with	7.2	9.2	0.2	7	85	12.5	21	3.5	0.75	6.3	5.5
CB08RS	●	●	without	8.2	9.5	0.05	8	95	15	24	4	0.85	7.2	6.3
CB08RS-B	●	●	with	8.2	9.6	0.05	8	95	15	24	4	0.85	7.2	6.3
CB08RS-02	●	●	without	8.2	9.5	0.2	8	95	15	24	4	0.85	7.2	6.3
CB08RS-02B	●	●	with	8.2	9.8	0.2	8	95	15	24	4	0.85	7.2	6.3

*1 DMIN : Min. Cutting Diameter

*2 The RE dimension represents the size before grinding a chip breaker.

RECOMMENDED CUTTING CONDITIONS

Workpiece Material	Micro-Mini Twin CB				Micro-Mini Twin CR		
	Cutting Speed (m/min)	Feed (mm/rev)	Depth of Cut (mm)	l/d	Cutting Speed (m/min)	Feed (mm/rev)	
						03RS/04RS	05RS
P Carbon Steel Alloy Steel 180-350HB	80 (40-120)	0.03 (0.01-0.05)	0.2 (0.1-0.3)	3-5	80 (40-120)	0.02 (0.01-0.03)	0.03 (0.01-0.05)
M Stainless Steel ≤200HB	80 (40-120)	0.03 (0.01-0.05)	0.2 (0.1-0.3)	3-5	80 (40-120)	0.02 (0.01-0.03)	0.03 (0.01-0.05)
K Gray Cast Iron ≤350MPa	80 (40-120)	0.03 (0.01-0.05)	0.2 (0.1-0.3)	3-5	80 (40-120)	0.03 (0.01-0.05)	0.03 (0.01-0.05)
N Non-Ferrous Material	120 (80-160)	0.05 (0.01-0.08)	0.3 (0.1-0.5)	3-5	120 (80-160)	0.03 (0.01-0.05)	0.05 (0.01-0.08)

Note 1) Recommend wet machining.

BORING BARS

MICRO-MINI TWIN



CR

For internal copying

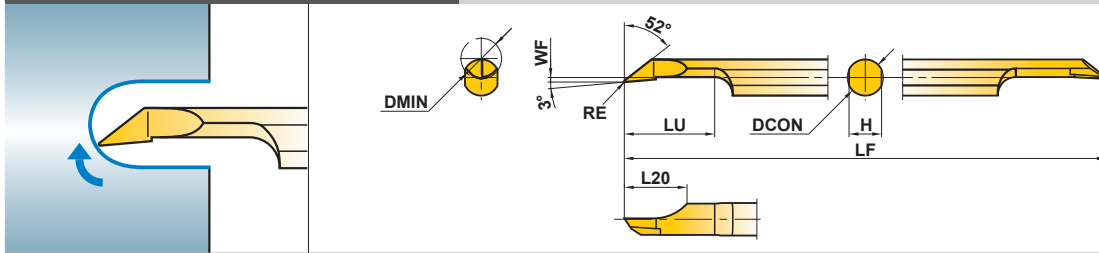

Right hand tool only.

Order Number	Stock		Breaker	Dimensions(mm)							
	Micro-Grain	Coated		DMIN	RE	DCON	LF	LU	L20	WF	H
	TF15	VP15TF									
CR03RS-01	●	●	without	3.5	0.1	3	50	8	6	0.15	2.7
CR03RS-01B	●	●	with	3.5	0.1	3	50	8	6	0.15	2.7
CR04RS-01	●	●	without	4.5	0.1	4	60	10	7	0.15	3.6
CR04RS-01B	●	●	with	4.5	0.1	4	60	10	7	0.15	3.6
CR05RS-01	●	●	without	5.5	0.1	5	70	12	8	0.15	4.5
CR05RS-01B	●	●	with	5.5	0.1	5	70	12	8	0.15	4.5

RECOMMENDED CUTTING CONDITIONS

Workpiece Material	Micro-Mini Twin CB				Micro-Mini Twin CR		
	Cutting Speed (m/min)	Feed (mm/rev)	Depth of Cut (mm)	l/d	Cutting Speed (m/min)	Feed(mm/rev)	
						03RS/04RS	05RS
P Carbon Steel Alloy Steel 180-350HB	80 (40-120)	0.03 (0.01-0.05)	0.2 (0.1-0.3)	3-5	80 (40-120)	0.02 (0.01-0.03)	0.03 (0.01-0.05)
M Stainless Steel ≤200HB	80 (40-120)	0.03 (0.01-0.05)	0.2 (0.1-0.3)	3-5	80 (40-120)	0.02 (0.01-0.03)	0.03 (0.01-0.05)
K Gray Cast Iron ≤350MPa	80 (40-120)	0.03 (0.01-0.05)	0.2 (0.1-0.3)	3-5	80 (40-120)	0.03 (0.01-0.05)	0.03 (0.01-0.05)
N Non-Ferrous Material	120 (80-160)	0.05 (0.01-0.08)	0.3 (0.1-0.5)	3-5	120 (80-160)	0.03 (0.01-0.05)	0.05 (0.01-0.08)

Note 1) Recommend wet machining.

Note 2) The recommended tool overhang of CR type is LU+2mm.

● : Inventory maintained in Japan.

(MICRO-MINI TWIN is available in 1 piece in one pack.)

■ PRECAUTIONS WHEN USING THE MICRO-MINI TWIN

● When using a holder for general purpose / small automatic lathe:

- ① To avoid chipping of the 2nd cutting edge take care when inserting the boring bar into the holder. Refer to fig.1. If the 2nd edge contacts the internal face of the holder there is a possibility that it may chip.

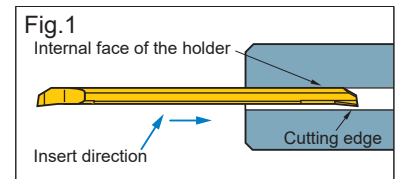

- ② When using this type of holder, there is a possibility that damage to the shank and the 2nd cutting edge can occur. Make sure that the clamping screws are tightened to the set torque value. Additionally make sure that there is no clamping screw near the 2nd cutting edge as this can break the boring bar.

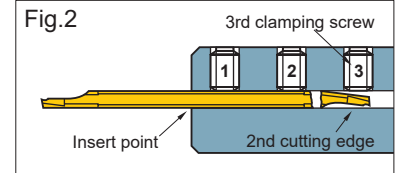

◎ When using Mitsubishi holders

When using holders with a tool overhang of recommended quantity, ensure that the 3rd clamping screw is removed prior to machining. (RBH1620N, RBH19020N, RBH2020N and RBH2520N do not have the 3rd screw.) The set torque value for clamping screw is 2.0 N•m.

● When using a square type holder:

- ① When installing the boring bar into the holder, tighten the clamp screws after ensuring the flats on the tool holder are parallel to the reference flats on the micro-mini bar. Refer to fig.3.
 ② Make sure that the clamping screws are tightened to the recommended values.
 ③ Do not tighten the clamp screw without a bar in place, otherwise the bridge will be deformed.

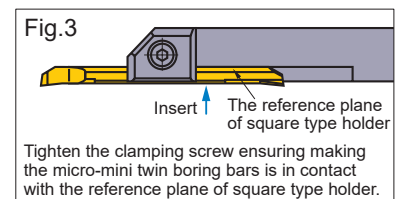

E

BORING BARS

MACHINING METHODS OF THE CR TYPE

● Profile turning

By drilling a pre-prepared hole, the machining time will be shortened and chip control will be improved.

<Cutting Conditions>

Workpiece : JIS S20C
 Tool : CR05RS-01B
 Cutting Speed : 80m/min
 Feed : 0.05mm/rev
 Depth of Cut : 0.05mm
 Wet Cutting

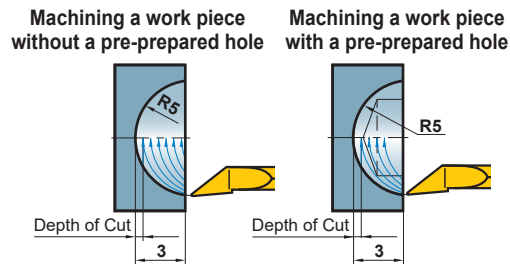

● Inner end facing

By drilling a pre-prepared hole, the machining time will be shortened and chip control will be improved.

<Cutting Conditions>

Workpiece : JIS S20C
 Tool : CR05RS-01B
 Cutting Speed : 80m/min
 Feed : 0.05mm/rev
 Depth of Cut : 0.05mm
 Wet Cutting

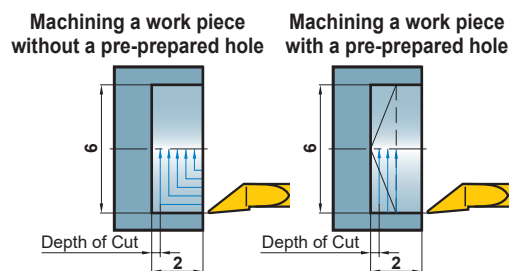

■ NOTES FOR USE

Profile turning, Inner end facing

The cutting edge should not be cross the centre line of the work piece.

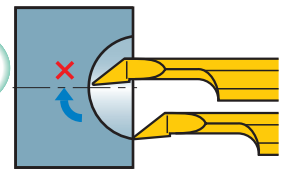

If the cutting edge crosses the centre line of a work piece, the cutting edge can fracture.

Copying

The depth of cut should be smaller than the corner radius value.

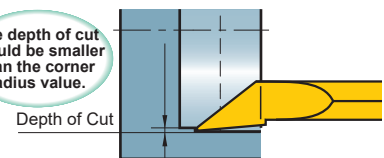

With depths of cut larger than the corner radius value, burrs will be formed.

BORING BARS

MICRO-MINI BORING BARS

- Solid carbide type with minimum cutting diameter $\phi 3.2\text{mm}$.
- l/d is 5 times the diameter.
- Cutting edge can be shaped according to the application thus, it covers a wide application range (threading, grooving, copying, etc).

94°



STANDARD MICRO-MINI BORING BARS (Solid carbide boring bar)

Order Number	Stock	Dimensions(mm)						Geometry
		CW	DCON	LF	LDRED	DMIN*	F2	
		TF15						
C03FR-BLS	●	2.0	3	80	15	3.2	1.0	
C04FR-BLS	●	2.5	4	80	20	4.2	1.5	
C05HR-BLS	●	3.0	5	100	25	5.2	2.0	

Right hand tool only.

*DMIN : Min. Cutting Diameter

BORING BARS

RECOMMENDED CUTTING CONDITIONS

	Workpiece Material	Cutting Speed (m/min)	Feed (mm/rev)	Depth of Cut (mm)	l/d	Edge Condition (mm)	
						*Corner Radius or BCH	*Honing
P	Carbon Steel, Alloy Steel 180-350HB	40 (30-50)	0.05 (-0.1)	0.2 (0.1-0.3)	5	0.1-0.5	0.01-0.05
M	Stainless Steel ≤200HB	40 (30-50)	0.05 (-0.1)	0.2 (0.1-0.3)	5	≤0.4	≤0.03 (Honing not required)
K	Gray Cast Iron ≤350MPa	40 (30-50)	0.05 (-0.05)	0.2 (0.1-0.3)	5	0.1-0.5	0.01-0.05
N	Non-Ferrous Material	80 (60-100)	0.05 (-0.1)	0.3 (0.1-0.5)	5	0.1-0.5	≤0.03 (Honing not required)

*Cutting edge is not honed. Please hone according to the workpiece before machining.

GRINDING THE CUTTING EDGE OF MICRO-MINI BORING BAR

- MICRO-MINI boring bar can be applied to boring and grooving without any modifications. It can also be reground as shown below.
- For shaping and regrinding, use a diamond whetstone approximately #250-#400. Please grind according to the application using the figure below as a reference.

Application	Boring	Grooving	Threading
Grinding Examples			

● : Inventory maintained in Japan.

(MICRO MINI is available in 1 piece in one pack.)

ROUND TYPE HOLDER

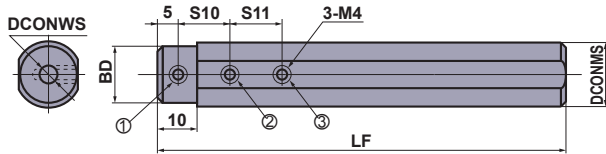

RBH158○N, RBH16○N, RBH190○N

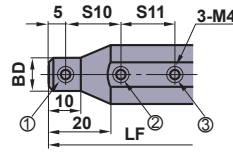

RBH20○N, RBH25○N, RBH254○N

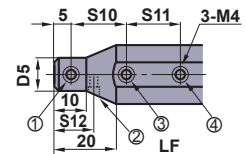

RBH22○N

Order Number	Stock	Dimensions(mm)						Micro-Mini C	Micro-Mini Twin		*1 Clamp Screw				Wrench	Torque (N·m)	
		DCONMS	DCONWS	BD	LF	S10	S11		S12	CB	CR	①	②	③			④
RBH15820N	●	15.875	2	15	100	10	—	—	02RS(-B) 02RS-0(B)	—	B	B	—	—	HKY20F	2.0	
RBH15830N	●	15.875	3	15	100	10	10	03FR-BLS	03RS(-B) 03RS-0(B)	03RS-01(B)	A	A	A	—	HKY20F	2.0	
RBH15840N	●	15.875	4	15	100	15	15	04FR-BLS	04RS(-B) 04RS-0(B)	04RS-01(B)	A	A	A	—	HKY20F	2.0	
RBH15850N	●	15.875	5	15	100	15	15	05HR-BLS	05RS(-B) 05RS-0(B)	05RS-01(B)	A	A	A	—	HKY20F	2.0	
RBH15860N	●	15.875	6	15	100	15	15	—	06RS(-B) 06RS-0(B)	—	A	A	A	—	HKY20F	2.0	
RBH15870N	●	15.875	7	15	100	20	20	—	07RS(-B) 07RS-0(B)	—	A	A	A	—	HKY20F	2.0	
RBH15880N	●	15.875	8	15	100	20	20	—	08RS(-B) 08RS-0(B)	—	D	D	D	—	HKY20F	2.0	
RBH1620N	●	16	2	15	100	10	—	—	02RS(-B) 02RS-0(B)	—	B	B	—	—	HKY20F	2.0	
RBH1630N	●	16	3	15	100	10	10	03FR-BLS	03RS(-B) 03RS-0(B)	03RS-01(B)	A	A	A	—	HKY20F	2.0	
RBH1640N	●	16	4	15	100	15	15	04FR-BLS	04RS(-B) 04RS-0(B)	04RS-01(B)	A	A	A	—	HKY20F	2.0	
RBH1650N	●	16	5	15	100	15	15	05HR-BLS	05RS(-B) 05RS-0(B)	05RS-01(B)	A	A	A	—	HKY20F	2.0	
RBH1660N	●	16	6	15	100	15	15	—	06RS(-B) 06RS-0(B)	—	A	A	A	—	HKY20F	2.0	
RBH1670N	●	16	7	15	100	20	20	—	07RS(-B) 07RS-0(B)	—	A	A	A	—	HKY20F	2.0	
RBH1680N	●	16	8	15	100	20	20	—	08RS(-B) 08RS-0(B)	—	D	D	D	—	HKY20F	2.0	
*2 RBH19020N	●	19.05	2	18	125	10	—	—	02RS(-B) 02RS-0(B)	—	C	C	—	—	HKY20F	2.0	
*2 RBH19030N	●	19.05	3	18	125	10	10	03FR-BLS	03RS(-B) 03RS-0(B)	03RS-01(B)	B	B	B	—	HKY20F	2.0	
*2 RBH19040N	●	19.05	4	18	125	15	15	04FR-BLS	04RS(-B) 04RS-0(B)	04RS-01(B)	B	B	B	—	HKY20F	2.0	
*2 RBH19050N	●	19.05	5	18	125	15	15	05HR-BLS	05RS(-B) 05RS-0(B)	05RS-01(B)	B	B	B	—	HKY20F	2.0	
*2 RBH19060N	●	19.05	6	18	125	15	15	—	06RS(-B) 06RS-0(B)	—	B	B	B	—	HKY20F	2.0	
*2 RBH19070N	●	19.05	7	18	125	20	20	—	07RS(-B) 07RS-0(B)	—	B	B	B	—	HKY20F	2.0	
RBH19080N	●	19.05	8	18	125	20	20	—	08RS(-B) 08RS-0(B)	—	A	A	A	—	HKY20F	2.0	
RBH2020N	●	20	2	11	125	10	—	—	02RS(-B) 02RS-0(B)	—	A	A	—	—	HKY20F	2.0	
RBH2030N	●	20	3	12	125	10	10	03FR-BLS	03RS(-B) 03RS-0(B)	03RS-01(B)	A	A	B	—	HKY20F	2.0	
RBH2040N	●	20	4	13	125	15	15	04FR-BLS	04RS(-B) 04RS-0(B)	04RS-01(B)	A	B	B	—	HKY20F	2.0	
RBH2050N	●	20	5	14	125	15	15	05HR-BLS	05RS(-B) 05RS-0(B)	05RS-01(B)	A	B	B	—	HKY20F	2.0	
RBH2060N	●	20	6	15	125	15	15	—	06RS(-B) 06RS-0(B)	—	A	B	B	—	HKY20F	2.0	
RBH2070N	●	20	7	16	125	20	20	—	07RS(-B) 07RS-0(B)	—	A	B	B	—	HKY20F	2.0	
RBH2080N	●	20	8	17	125	20	20	—	08RS(-B) 08RS-0(B)	—	A	A	A	—	HKY20F	2.0	
RBH2220N	●	22	2	11	125	10	—	10	02RS(-B) 02RS-0(B)	—	A	B	—	A	HKY20F	2.0	
RBH2230N	●	22	3	12	125	10	10	10	03FR-BLS	03RS(-B) 03RS-0(B)	A	B	C	A	HKY20F	2.0	
RBH2240N	●	22	4	13	125	15	15	12.5	04FR-BLS	04RS(-B) 04RS-0(B)	A	B	B	A	HKY20F	2.0	
RBH2250N	●	22	5	14	125	15	15	12.5	05HR-BLS	05RS(-B) 05RS-0(B)	A	B	B	A	HKY20F	2.0	
RBH2260N	●	22	6	15	125	15	15	15	—	06RS(-B) 06RS-0(B)	—	A	B	B	A	HKY20F	2.0
RBH2270N	●	22	7	16	125	20	20	15	—	07RS(-B) 07RS-0(B)	—	A	B	B	A	HKY20F	2.0
RBH2280N	●	22	8	17	125	20	20	15	—	08RS(-B) 08RS-0(B)	—	A	B	B	A	HKY20F	2.0
RBH2520N	●	25	2	11	150	10	—	—	02RS(-B) 02RS-0(B)	—	A	B	—	—	HKY20F	2.0	
RBH2530N	●	25	3	12	150	10	10	—	03FR-BLS	03RS(-B) 03RS-0(B)	A	B	C	—	HKY20F	2.0	
RBH2540N	●	25	4	13	150	15	15	—	04FR-BLS	04RS(-B) 04RS-0(B)	A	C	C	—	HKY20F	2.0	
RBH2550N	●	25	5	14	150	15	15	—	05HR-BLS	05RS(-B) 05RS-0(B)	A	C	C	—	HKY20F	2.0	
RBH2560N	●	25	6	15	150	15	15	—	06RS(-B) 06RS-0(B)	—	A	C	C	—	HKY20F	2.0	
RBH2570N	●	25	7	16	150	20	20	—	07RS(-B) 07RS-0(B)	—	A	C	C	—	HKY20F	2.0	
RBH2580N	●	25	8	17	150	20	20	—	08RS(-B) 08RS-0(B)	—	A	B	B	—	HKY20F	2.0	
RBH25420N	●	25.4	2	11	150	10	—	—	02RS(-B) 02RS-0(B)	—	A	B	—	—	HKY20F	2.0	
RBH25430N	●	25.4	3	12	150	10	10	—	03FR-BLS	03RS(-B) 03RS-0(B)	A	B	C	—	HKY20F	2.0	
RBH25440N	●	25.4	4	13	150	15	15	—	04FR-BLS	04RS(-B) 04RS-0(B)	A	C	C	—	HKY20F	2.0	
RBH25450N	●	25.4	5	14	150	15	15	—	05HR-BLS	05RS(-B) 05RS-0(B)	A	C	C	—	HKY20F	2.0	
RBH25460N	●	25.4	6	15	150	15	15	—	06RS(-B) 06RS-0(B)	—	A	C	C	—	HKY20F	2.0	
RBH25470N	●	25.4	7	16	150	20	20	—	07RS(-B) 07RS-0(B)	—	A	C	C	—	HKY20F	2.0	
RBH25480N	●	25.4	8	17	150	20	20	—	08RS(-B) 08RS-0(B)	—	A	B	B	—	HKY20F	2.0	

*1 Order number of clamp screw A=HSS04004, B=HSS04006, C=HSS04008, D=HSS04003 *2 Revised order number.

Conventional Order Number	Revised Order Number	Conventional Order Number	Revised Order Number
RBH1920N	RBH19020N	RBH1950N	RBH19050N
RBH1930N	RBH19030N	RBH1960N	RBH19060N
RBH1940N	RBH19040N	RBH1970N	RBH19070N

SPARE PARTS > P001
TECHNICAL DATA > Q001

MICRO-MINI TWIN



■ SQUARE TYPE HOLDER

CB type (Boring bar fits to a holder)

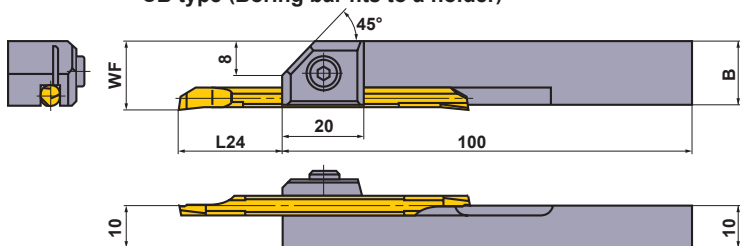

CR type (Boring bar fits to a holder)

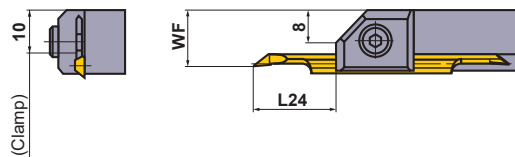

Order Number	Stock	Dimensions(mm)						Micro-Mini Twin		Clamp Screw	Wrench	Torque (N·m)
		WF		L24 *		B		CB	CR			
		CB	CR	CB	CR	CB	CR					
SBH1020R	●	13	—	6—24 (6—10)	—	12.9	02RS(-B) 02RS-0(B)	—	HSC04010	HKY30R	4.8	
SBH1030R	●	14	12.65	8.5—22 (9—15)	11—19.5 (12)	13.8	03RS(-B) 03RS-0(B)	03RS-01(B)	HSC05012	HKY40R	9.5	
SBH1040R	●	15	13.15	11—29.5 (12—20)	13—27.5 (14)	14.7	04RS(-B) 04RS-0(B)	04RS-01(B)	HSC05012	HKY40R	9.5	
SBH1050R	●	16	13.65	13.5—37 (15—25)	15—35.5 (16)	15.6	05RS(-B) 05RS-0(B)	05RS-01(B)	HSC05012	HKY40R	9.5	
SBH1060R	●	17	—	13.5—42 (18—30)	—	16.5	06RS(-B) 06RS-0(B)	—	HSC05012	HKY40R	9.5	
SBH1070R	●	18	—	13.5—52 (21—35)	—	17.4	07RS(-B) 07RS-0(B)	—	HSC05012	HKY40R	9.5	

Note 1) The MICRO-DEX and the MICRO-MINI cannot be fit to square holders.

*L24 is the length of overhang for sufficient clamping, and () is the recommended length for machining of carbon and alloy steel.

F TYPE BORING BARS

- The minimum cutting diameter is from $\phi 10$.
- 11° positive insert.
- Screw-on type.
- l/d is 3 to 5 times the diameter (Carbide shank is 7 times the diameter).

FSTU1

TP \odot inserts

Finish	Flat Top
R/L  (08,09,11)	 (08,09,11)
PCD	CBN/PCD
R/L-F  (09,11)	 (08,09,11)

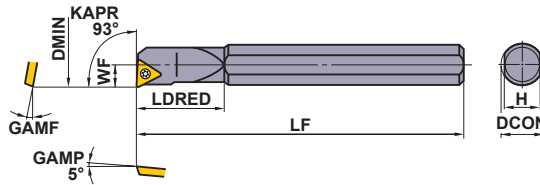
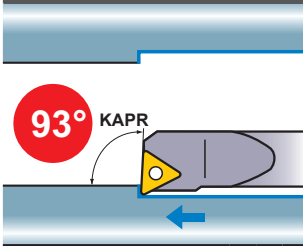

Right hand tool holder shown.

Order Number	Stock		Insert Number	Dimensions(mm)							* 		
	R	L		DCON	LF	LDRED	WF	H	GAMF	DMIN	Clamp Screw	Wrench	
FSTU108R/L	●	●	TPGX TPMX	0802 \odot	8	125	18	5	7	15°	10	CS200T	TKY06F
FSTU110R/L	●	●		0902 \odot	10	150	22	6	9	13°	12	CS250T	TKY08F
FSTU112R/L	●	●		0902 \odot	12	180	25	8	11	10°	16	CS250T	TKY08F
FSTU116R/L	●	●		1103 \odot	16	200	30	11	14	7°	22	CS300890T	TKY08F

* Clamp Torque (N · m) : CS200T=0.6, CS250T=1.0, CS300890T=1.0

FSTU2

Carbide shank

TP \odot inserts

Finish	Flat Top
R/L  (08,09,11)	 (08,09,11)
PCD	CBN/PCD
R/L-F  (09,11)	 (08,09,11)

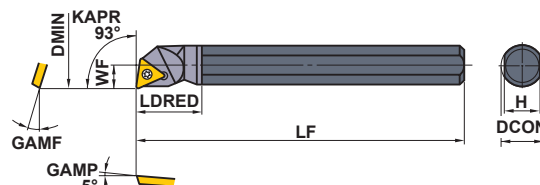
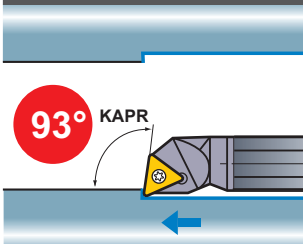

Right hand tool holder shown.

Order Number	Stock		Insert Number	Dimensions(mm)							* 		
	R	L		DCON	LF	LDRED	WF	H	GAMF	DMIN	Clamp Screw	Wrench	
FSTU208R/L	●	●	TPGX TPMX	0802 \odot	8	125	13	5	7	15°	10	CS200T	TKY06F
FSTU210R/L	●	●		0902 \odot	10	150	16	6	9	13°	12	CS250T	TKY08F
FSTU212R/L	●	●		0902 \odot	12	180	19	8	11	10°	16	CS250T	TKY08F
FSTU216R/L	●	●		1103 \odot	16	200	26	11	14	7°	22	CS300890T	TKY08F

* Clamp Torque (N · m) : CS200T=0.6, CS250T=1.0, CS300890T=1.0

RECOMMENDED CUTTING CONDITIONS

Steel Shank			l/d ≤ 3			l/d = 3-4 (Shank Diameter ≥ 25mm)		
Carbide Shank			l/d ≤ 5			l/d = 6-7		
Workpiece Material	Hardness	Cutting Mode	Cutting Speed (m/min)	Feed (mm/rev)	Depth of Cut (mm)	Cutting Speed (m/min)	Feed (mm/rev)	Depth of Cut (mm)
P Carbon Steel Alloy Steel	180-350HB	Light Cutting	130 (90-160)	0.1 (0.05-0.15)	0.2	120 (80-150)	0.1 (0.05-0.15)	0.2
		Medium Cutting	90 (60-120)	0.25 (0.15-0.35)	-3.0	80 (50-110)	0.15 (0.1-0.2)	-1.5
M Stainless Steel	≤200HB	Light Cutting	140 (100-180)	0.1 (0.05-0.15)	0.2	140 (100-180)	0.1 (0.05-0.15)	0.2
		Medium Cutting	70 (50-90)	0.2 (0.15-0.25)	-2.0	60 (40-80)	0.15 (0.1-0.2)	-1.0
N Aluminium Alloy	-	Light Cutting	300 (200-400)	0.1 (0.05-0.15)	0.2	300 (200-400)	0.1 (0.05-0.15)	0.2
		Medium Cutting	200 (150-250)	0.1 (0.05-0.15)	-2.0	200 (150-250)	0.1 (0.05-0.15)	-1.5

Note 1) The insert photos are only examples. The letters refer to the chip breaker and the dimension refers to the inscribed circle.

Note 2) Dimensions shown for insert corner RE 0.4.

Note 3) When using insert with right and left hand chip breaker, please use left hand insert for right hand holder and right hand insert for left hand holder.

TP \odot type inserts > A140, A141
CBN & PCD inserts > B048, B062, B063

SPARE PARTS > P001
TECHNICAL DATA > Q001





BORING BARS

F TYPE BORING BARS

- The minimum cutting diameter is from $\phi 22$.
- 11° positive insert.
- Clamp-on type.
- l/d is 3 to 5 times the diameter (Carbide shank is 7 times the diameter).

FCTU1

TP \odot inserts

M Class	M Class	G class
Standard		R/L
 (11,16)	 (11,16)	 (11,16)
G class	CBN/PCD	
 (11,16)	 (11,16)	

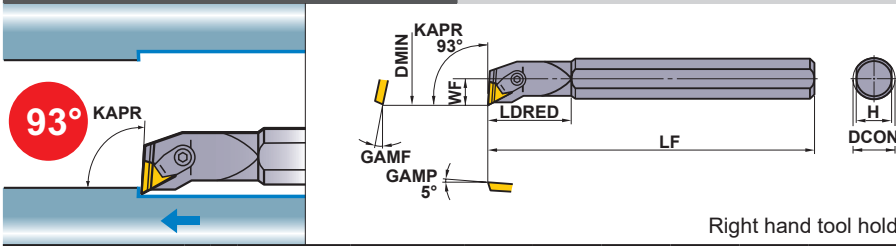





Order Number	Stock		Insert Number	Dimensions(mm)							Tools					
	R	L		DCON	LF	LDRED	WF	H	GAMF	DMIN	Shim	Shim Pin	Clamp Set *	Breaker Piece	Wrench	
FCTU116R/L	●	●	TPMN TPMR TPGN TPGR	1103 \odot	16	200	30	11	14	7°	22	—	—	C3	CBT2N	HKY25R
FCTU120R/L ☆	●	●		1603 \odot	20	200	37	13	18	5°	26	—	—	C4	CBT3F	HKY30R
FCTU125R/L ☆ (4 Side Flat Shank)	●	●		1603 \odot	25	250	40	16	22	5°	32	PT32	BCP202	C4	CBT3F	HKY30R
FCTU132R/L ☆ (4 Side Flat Shank)	●	●		1603 \odot	32	300	45	20	29	0°	40	PT32	BCP201	C4	CBT3F	HKY30R

* Clamp Torque (N · m) : C3=2.2, C4=3.3

FCTU2

Carbide shank

TP \odot inserts

M Class	M Class	G class
Standard		R/L
 (11,16)	 (11,16)	 (11,16)
G class	CBN/PCD	
 (11,16)	 (11,16)	

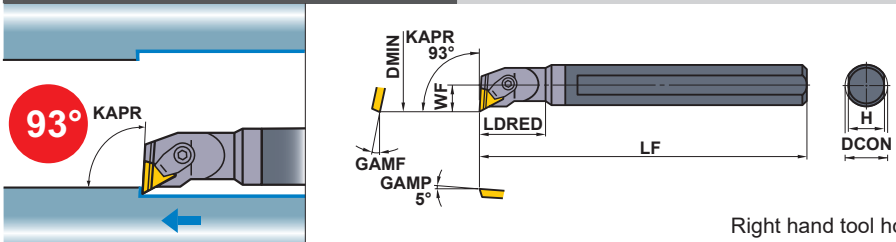

Order Number	Stock		Insert Number	Dimensions(mm)							Tools					
	R	L		DCON	LF	LDRED	WF	H	GAMF	DMIN	Shim	Shim Pin	Clamp Set *	Breaker Piece	Wrench	
FCTU216R	●	●	TPMN TPMR TPGN TPGR	1103 \odot	16	200	26	11	14	7°	22	—	—	C3	CBT2N	HKY25R
FCTU220R ☆	●	●		1603 \odot	20	200	33	13	18	5°	26	—	—	C4	CBT3F	HKY30R
FCTU225R ☆	●	●		1603 \odot	25	250	37	16	22	5°	32	PT32	BCP202	C4	CBT3F	HKY30R

* Clamp Torque (N · m) : C3=2.2, C4=3.3

Note 1) The insert photos are only examples. The letters refer to the chip breaker and the dimension refers to the inscribed circle.

Note 2) Dimensions shown for insert corner RE 0.4. (Model of ☆ Mark is RE 0.8)

Note 3) When using insert with right and left hand chip breaker, please use left hand insert for right hand holder and right hand insert for left hand holder.

● : Inventory maintained in Japan.

TP \odot type inserts > A157
CBN & PCD inserts > B053, B068

F TYPE BORING BARS

- The minimum cutting diameter is from $\phi 5.8$.
- 7° positive insert.
- Screw-on type.
- l/d is 3 to 5 times the diameter (Carbide shank is 7 times the diameter).

FSWL1

WC \odot inserts

Finish	Light
R/L (02,L3)	Standard (02,L3,04,06)
CBN/PCD (L3,04,06)	

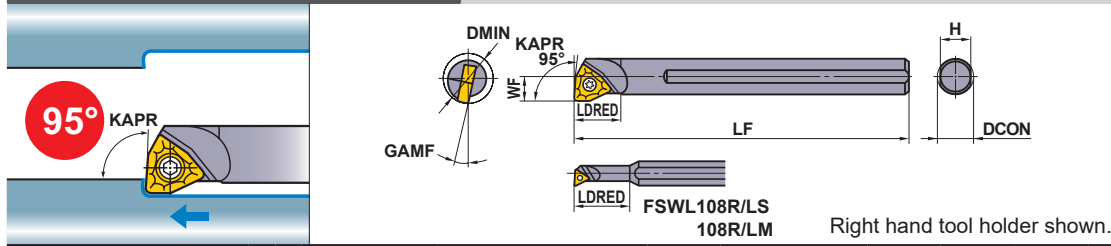

Order Number	Stock		Insert Number	Dimensions(mm)							*		
	R	L		DCON	LF	LDRED	WF	H	GAMF	DMIN	Clamp Screw	Wrench	
FSWL108R/LS	●	●	WCMT WCGT	0201 \odot	8	100	19	2.9	7	17°	5.8	TS21	TKY06F
FSWL108R/LM	●	●	WCMT WCGT WCMW	L302 \odot	8	100	25	4	7	15°	8	TS2	TKY06F
FSWL108R/L	●	●	WCMT WCMW	0402 \odot	8	125	10	5	7	15°	10	TS25	TKY08F
FSWL110R/L	●	●		0402 \odot	10	150	12	6	9	13°	12	TS25	TKY08F
FSWL112R/L	☆	●		06T3 \odot	12	180	15	8	11	13°	16	TS4	TKY15F
FSWL116R/L	☆	●		06T3 \odot	16	200	20	11	14	7°	22	TS4	TKY15F

* Clamp Torque (N · m) : TS21=0.6, TS2=0.6, TS25=1.0, TS4=3.5

FSWL2

Carbide shank

WC \odot inserts

Finish	Light
R/L (02,L3)	Standard (02,L3,04,06)
CBN/PCD (L3,04,06)	

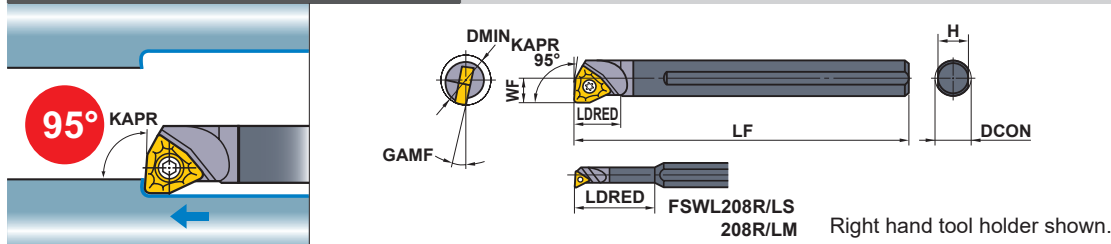

Order Number	Stock		Insert Number	Dimensions(mm)							*		
	R	L		DCON	LF	LDRED	WF	H	GAMF	DMIN	Clamp Screw	Wrench	
FSWL208R/LS	●	●	WCMT WCGT	0201 \odot	8	122	25	2.9	7	17°	5.8	TS21	TKY06F
FSWL208R/LM	●	●	WCMT WCGT WCMW	L302 \odot	8	125	33	4	7	15°	8	TS2	TKY06F
FSWL208R/L	●	●	WCMT WCMW	0402 \odot	8	125	10	5	7	15°	10	TS25	TKY08F
FSWL210R/L	●	●		0402 \odot	10	150	12	6	9	13°	12	TS25	TKY08F
FSWL212R/L	☆	●		06T3 \odot	12	180	15	8	11	13°	16	TS4	TKY15F
FSWL216R/L	☆	●		06T3 \odot	16	200	20	11	14	7°	22	TS4	TKY15F

* Clamp Torque (N · m) : TS21=0.6, TS2=0.6, TS25=1.0, TS4=3.5

RECOMMENDED CUTTING CONDITIONS

Steel Shank			l/d ≤ 3			l/d = 3-4 (Shank Diameter ≥ 25mm)		
Carbide Shank			l/d ≤ 5			l/d = 6-7		
Workpiece Material	Hardness	Cutting Mode	Cutting Speed (m/min)	Feed (mm/rev)	Depth of Cut (mm)	Cutting Speed (m/min)	Feed (mm/rev)	Depth of Cut (mm)
P Carbon Steel Alloy Steel	180-350HB	Light Cutting	130 (90-160)	0.1 (0.05-0.15)	0.2	120 (80-150)	0.1 (0.05-0.15)	0.2
		Medium Cutting	90 (60-120)	0.25 (0.15-0.35)	-3.0	80 (50-110)	0.15 (0.1-0.2)	-1.5
M Stainless Steel	≤200HB	Light Cutting	140 (100-180)	0.1 (0.05-0.15)	0.2	140 (100-180)	0.1 (0.05-0.15)	0.2
		Medium Cutting	70 (50-90)	0.2 (0.15-0.25)	-2.0	60 (40-80)	0.15 (0.1-0.2)	-1.0
N Aluminium Alloy	-	Light Cutting	300 (200-400)	0.1 (0.05-0.15)	0.2	300 (200-400)	0.1 (0.05-0.15)	0.2
		Medium Cutting	200 (150-250)	0.1 (0.05-0.15)	-2.0	200 (150-250)	0.1 (0.05-0.15)	-1.5

WC \odot type inserts	➤ A151
CBN & PCD inserts	➤ B051, B065
SPARE PARTS	➤ P001
TECHNICAL DATA	➤ Q001

BORING BARS

S TYPE BORING BARS





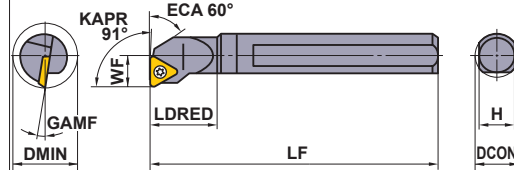
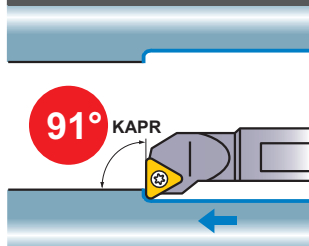

- The minimum cutting diameter is from $\phi 11$.
- ISO standard.
- 7° positive insert.
- Screw-on type.
- l/d is 3 to 5 times the diameter (Carbide shank is 7 times the diameter).



S O O O STFC

TC O O inserts



Right hand tool holder shown.

Finish	Finish	Light	Light
FP	FM	LP	LM
			
(09,11,16)	(09,11,16)	(09,11,16)	(09,11,16)
Medium	Medium	Flat top	CBN/PCD
			
(09,11,16)	(09,11,16)	(11,16)	(09,11,16)

Order Number	Stock		Insert Number	Dimensions(mm)						*  			
	R	L		DCON	LF	LDRED	WF	H	GAMF	DMIN	Clamp Screw	Wrench	
S08FSTFCR/L09	●	●	TCMT TCGW	0902	8	80	12	6	7	15°	11	TS22	TKY06F
S10HSTFCR/L11	●	●	TCMW TCMT TCGW TCGT	1102	10	100	16	7	9	13°	13	TS25	TKY08F
S12KSTFCR/L11	●	●		1102	12	125	20	9	11	10°	16	TS25	TKY08F
S16MSTFCR/L11	●	●		1102	16	150	25	11	14	7°	20	TS25	TKY08F
S20QSTFCR/L16 ☆	●	●		16T3	20	180	32	13	18	7°	25	TS4	TKY15F
S25RSTFCR/L16 ☆	●	●		16T3	25	200	40	17	23	5°	32	TS4	TKY15F
S32SSTFCR/L16 ☆	●	●		16T3	32	250	50	22	30	5°	40	TS4	TKY15F







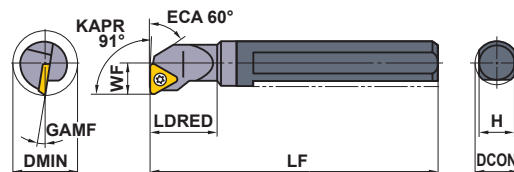
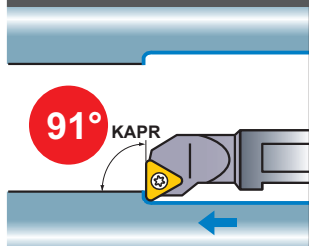

* Clamp Torque (N · m) : TS22=0.6, TS25=1.0, TS4=3.5



C O O O STFC

Carbide shank TC O O inserts



Right hand tool holder only.

Finish	Finish	Light	Light
FP	FM	LP	LM
			
(09,11,16)	(09,11,16)	(09,11,16)	(09,11,16)
Medium	Medium	Flat top	CBN/PCD
			
(09,11,16)	(09,11,16)	(11,16)	(11)

Order Number	Stock		Insert Number	Dimensions(mm)						*  			
	R	L		DCON	LF	LDRED	WF	H	GAMF	DMIN	Clamp Screw	Wrench	
C08HSTFCR09	●		TCMT TCGW	0902	8	100	12	6	7	15°	11	TS22	TKY06F
C10KSTFCR11	●		TCMW TCMT TCGW TCGT	1102	10	125	16	7	9	13°	13	TS25	TKY08F
C12MSTFCR11	●			1102	12	150	20	9	11	10°	16	TS25	TKY08F
C16RSTFCR11	●			1102	16	200	25	11	14	7°	20	TS25	TKY08F
C20SSTFCR16 ☆	●			16T3	20	250	32	13	18	7°	25	TS4	TKY15F
C25TSTFCR16 ☆	●			16T3	25	300	40	17	23	5°	32	TS4	TKY15F

* Clamp Torque (N · m) : TS22=0.6, TS25=1.0, TS4=3.5

Note 1) The insert photos are only examples. The letters refer to the chip breaker and the dimension refers to the inscribed circle.

Note 2) Dimensions shown for insert corner RE 0.4.(Model of ☆ Mark is RE 0.8)

Note 3) When using insert with right and left hand chip breaker, please use left hand insert for right hand holder and right hand insert for left hand holder.

● : Inventory maintained in Japan.

TC O O type inserts > A135—A137
CBN & PCD inserts > B046, B061

SDUC DC inserts

Right hand tool holder shown.

Finish	Finish	Light	Light
FP (07,11)	FM (07,11)	LP (07,11)	LM (07,11)
Medium	Medium	Medium	Flat top
MP (07,11,15)	MM (07,11,15)	Standard (07,11,15)	(07,11,15)

Order Number	Stock		Insert Number	Dimensions(mm)							GAMF	DMIN	* Clamp Screw	Wrench
	R	L		DCON	LF	LDRED	WF	WF2	H					
S10HSDUCR/L07	●	●	DCMT DCET DCGT DCMW DCGW	0702	10	100	16	7	2.4	9	13°	13	TS25	TKY08F
S12KSDUCR/L07	●	●		0702	12	125	20	9	3.4	11	10°	16	TS25	TKY08F
S16MSDUCR/L07	●	●		0702	16	150	25	11	3.9	14	7°	20	TS25	TKY08F
S20QSDUCR/L11	☆	●		11T3	20	180	32	13	4.4	18	7°	25	TS4	TKY15F
S25RSDUCR/L15	☆	●		1504	25	200	40	17	6.9	23	5°	32	TS5	TKY25F
S32SSDUCR/L15	☆	●		1504	32	250	50	22	8.4	30	5°	40	TS5	TKY25F
S40TSDUCR/L15	☆	●		1504	40	300	63	27	9.4	37	5°	50	TS5	TKY25F

* Clamp Torque (N • m) : TS25=1.0, TS4=3.5, TS5=7.5

CSDUC Carbide shank DC inserts

Right hand tool holder only.

Finish	Finish	Light	Light
FP (07,11)	FM (07,11)	LP (07,11)	LM (07,11)
Medium	Medium	Medium	Flat top
MP (07,11,15)	MM (07,11,15)	Standard (07,11,15)	(07,11,15)

Order Number	Stock		Insert Number	Dimensions(mm)							GAMF	DMIN	* Clamp Screw	Wrench
	R	L		DCON	LF	LDRED	WF	WF2	H					
C10KSDUCR07	●	●	DCMT DCET DCGT DCMW DCGW	0702	10	125	16	7	2.1	9	13°	13	TS25	TKY08F
C12MSDUCR07	●	●		0702	12	150	20	9	3.1	11	10°	16	TS25	TKY08F
C16RSDUCR07	●	●		0702	16	200	25	11	3.1	14	7°	20	TS25	TKY08F
C20SSDUCR11	☆	●		11T3	20	250	32	13	3.1	18	7°	25	TS4	TKY15F
C25TSDUCR15	☆	●		1504	25	300	40	17	4.9	23	5°	32	TS5	TKY25F

* Clamp Torque (N • m) : TS25=1.0, TS4=3.5, TS5=7.5

RECOMMENDED CUTTING CONDITIONS

Steel Shank			l/d ≤ 3			l/d = 3-4 (Shank Diameter ≥ 25mm)		
Carbide Shank			l/d ≤ 5			l/d = 6-7		
Workpiece Material	Hardness	Cutting Mode	Cutting Speed (m/min)	Feed (mm/rev)	Depth of Cut (mm)	Cutting Speed (m/min)	Feed (mm/rev)	Depth of Cut (mm)
P Carbon Steel Alloy Steel	180-350HB	Light Cutting	130 (90-160)	0.1 (0.05-0.15)	0.2	120 (80-150)	0.1 (0.05-0.15)	0.2
		Medium Cutting	90 (60-120)	0.25 (0.15-0.35)	-3.0	80 (50-110)	0.15 (0.1-0.2)	-1.5
M Stainless Steel	≤200HB	Light Cutting	140 (100-180)	0.1 (0.05-0.15)	0.2	140 (100-180)	0.1 (0.05-0.15)	0.2
		Medium Cutting	70 (50-90)	0.2 (0.15-0.25)	-2.0	60 (40-80)	0.15 (0.1-0.2)	-1.0
N Aluminium Alloy	-	Light Cutting	300 (200-400)	0.1 (0.05-0.15)	0.2	300 (200-400)	0.1 (0.05-0.15)	0.2
		Medium Cutting	200 (150-250)	0.1 (0.05-0.15)	-2.0	200 (150-250)	0.1 (0.05-0.15)	-1.5

DC type inserts	> A124-A129
CBN & PCD inserts	> B044, B045, B060
SPARE PARTS	> P001
TECHNICAL DATA	> Q001

BORING BARS

S TYPE BORING BARS

- The minimum cutting diameter is from $\phi 11$.
- ISO standard.
- 7° positive insert.
- Screw-on type.

- l/d is 3 to 5 times the diameter (Carbide shank is 7 times the diameter).

S		SCLC		CC inserts						Finish	Finish	Light	Light
								FP	FM	LP	LM		
		Right hand tool holder shown.						(06,09)	(06,09)	(06,09)	(06,09)		
								Medium	Medium	Flat top	CBN/PCD		
								MP	MM				
								(06,09,12)	(06,09,12)	(06,09,12)	(06,09,12)		
Order Number	Stock		Insert Number	Dimensions(mm)						DMIN	*		
	R	L		DCON	LF	LDRED	WF	H	GAMF				Clamp Screw
S08FSCLCR/L06	●	●	0602	8	80	12	6	7	15°	11	TS25	TKY08F	
S10HSCLCR/L06	●	●	CCMB	10	100	16	7	9	13°	13	TS25	TKY08F	
S12KSCLCR/L06	●	●	CCMH	12	125	20	9	11	10°	16	TS25	TKY08F	
S16MSCLCR/L09	●	●	CCMT	16	150	25	11	14	7°	20	TS4	TKY15F	
S20QSCLCR/L09	☆	●	CCMW	20	180	32	13	18	7°	25	TS4	TKY15F	
S25RSCLCR/L12	☆	●	CCET	25	200	40	17	23	5°	32	TS5	TKY25F	
S32SSCLCR/L12	☆	●	CCGB	32	250	50	22	30	5°	40	TS5	TKY25F	
S40TSCLCR/L12	☆	●	CCGH	40	300	63	27	37	5°	50	TS5	TKY25F	
			CCGT										
			CCGW										
			1204										
			1204										

* Clamp Torque (N · m) : TS25=1.0, TS4=3.5, TS5=7.5

C		SCLC		Carbide shank CC inserts						Finish	Finish	Light	Light
								FP	FM	LP	LM		
		Right hand tool holder only.						(06,09)	(06,09)	(06,09)	(06,09)		
								Medium	Medium	Flat top	CBN/PCD		
								MP	MM				
								(06,09)	(06,09)	(06,09)	(06,09)		
Order Number	Stock		Insert Number	Dimensions(mm)						DMIN	*		
	R	L		DCON	LF	LDRED	WF	H	GAMF				Clamp Screw
C08HSCLCR06	●	●	0602	8	100	12	6	7	15°	11	TS25	TKY08F	
C10KSCLCR06	●	●	CCMB	10	125	16	7	9	13°	13	TS25	TKY08F	
C12MSCLCR06	●	●	CCMH	12	150	20	9	11	10°	16	TS25	TKY08F	
C16RSCLCR09	☆	●	CCMT	16	200	25	11	14	7°	20	TS4	TKY15F	
C20SSCLCR09	☆	●	CCMW	20	250	32	13	18	7°	25	TS4	TKY15F	
			CCET										
			CCGB										
			CCGH										
			09T3										
			09T3										

* Clamp Torque (N · m) : TS25=1.0, TS4=3.5

Note 1) The insert photos are only examples. The letters refer to the chip breaker and the dimension refers to the inscribed circle.

Note 2) Dimensions shown for insert corner RE 0.4.(Model of ☆ Mark is RE 0.8)

Note 3) When using insert with right and left hand chip breaker, please use left hand insert for right hand holder and right hand insert for left hand holder.

● : Inventory maintained in Japan.

CC type inserts > A114-A121

CBN & PCD inserts > B040-B042, B059

S₀₀₀SDQC DC₀₀₀inserts

Finish	Finish	Light	Light
FP (07,11)	FM (07,11)	LP (07,11)	LM (07,11)
Medium	Medium	Flat top	CBN/PCD
MP (07,11,15)	MM (07,11,15)	(07,11,15)	(07,11)

Right hand tool holder shown.

Order Number	Stock		Insert Number	Dimensions(mm)							GAMF	DMIN	* Clamp Screw	Wrench
	R	L		DCON	LF	LDRED	WF	WF2	H					
S10HSDQCR/L07	●	●	DCMT DCET DCGT DCMW DCGW	0702 ₀₀₀	10	100	16	7	2.4	9	13°	13	TS25	TKY08F
S12KSDQCR/L07	●	●		0702 ₀₀₀	12	125	20	9	3.4	11	10°	16	TS25	TKY08F
S16MSDQCR/L07	●	●		0702 ₀₀₀	16	150	25	11	3.9	14	7°	20	TS25	TKY08F
S20QSDQCR/L11	☆	●		11T3 ₀₀₀	20	180	32	13	4.4	18	7°	25	TS4	TKY15F
S25RSDQCR/L15	☆	●		1504 ₀₀₀	25	200	40	17	6.9	23	5°	32	TS5	TKY25F
S32SSDQCR15	☆	●		1504 ₀₀₀	32	250	50	22	8.4	30	5°	40	TS5	TKY25F
S40TSDQCR15	☆	●		1504 ₀₀₀	40	300	63	27	9.4	37	5°	50	TS5	TKY25F

* Clamp Torque (N • m) : TS25=1.0, TS4=3.5, TS5=7.5

C₀₀₀SDQC Carbide shank DC₀₀₀inserts

Finish	Finish	Light	Light
FP (07,11)	FM (07,11)	LP (07,11)	LM (07,11)
Medium	Medium	Flat top	CBN/PCD
MP (07,11,15)	MM (07,11,15)	(07,11,15)	(07,11)

Right hand tool holder only.

Order Number	Stock		Insert Number	Dimensions(mm)							GAMF	DMIN	* Clamp Screw	Wrench
	R	L		DCON	LF	LDRED	WF	WF2	H					
C10KSDQCR07	●	●	DCMT DCET DCGT DCMW DCGW	0702 ₀₀₀	10	125	16	7	2.1	9	13°	13	TS25	TKY08F
C12MSDQCR07	●	●		0702 ₀₀₀	12	150	20	9	3.1	11	10°	16	TS25	TKY08F
C16RSDQCR07	●	●		0702 ₀₀₀	16	200	25	11	3.1	14	7°	20	TS25	TKY08F
C20SSDQCR11	☆	●		11T3 ₀₀₀	20	250	32	13	3.1	18	7°	25	TS4	TKY15F
C25TSDQCR15	☆	●		1504 ₀₀₀	25	300	40	17	4.9	23	5°	32	TS5	TKY25F

* Clamp Torque (N • m) : TS25=1.0, TS4=3.5, TS5=7.5

RECOMMENDED CUTTING CONDITIONS

Steel Shank			l/d ≤ 3			l/d = 3-4 (Shank Diameter ≥ 25mm)		
Carbide Shank			l/d ≤ 5			l/d = 6-7		
Workpiece Material	Hardness	Cutting Mode	Cutting Speed (m/min)	Feed (mm/rev)	Depth of Cut (mm)	Cutting Speed (m/min)	Feed (mm/rev)	Depth of Cut (mm)
P Carbon Steel Alloy Steel	180-350HB	Light Cutting	130 (90-160)	0.1 (0.05-0.15)	0.2	120 (80-150)	0.1 (0.05-0.15)	0.2
		Medium Cutting	90 (60-120)	0.25 (0.15-0.35)	-3.0	80 (50-110)	0.15 (0.1-0.2)	-1.5
M Stainless Steel	≤200HB	Light Cutting	140 (100-180)	0.1 (0.05-0.15)	0.2	140 (100-180)	0.1 (0.05-0.15)	0.2
		Medium Cutting	70 (50-90)	0.2 (0.15-0.25)	-2.0	60 (40-80)	0.15 (0.1-0.2)	-1.0
N Aluminium Alloy	-	Light Cutting	300 (200-400)	0.1 (0.05-0.15)	0.2	300 (200-400)	0.1 (0.05-0.15)	0.2
		Medium Cutting	200 (150-250)	0.1 (0.05-0.15)	-2.0	200 (150-250)	0.1 (0.05-0.15)	-1.5

DC ₀₀₀ type inserts	> A124-A129
CBN & PCD inserts	> B044, B045, B060
SPARE PARTS	> P001
TECHNICAL DATA	> Q001

BORING BARS

S TYPE BORING BARS



- The minimum cutting diameter is from $\phi 20$.
- ISO standard.
- 7° positive insert.
- Screw-on type.

- l/d is 3 to 5 times the diameter (Carbide shank is 7 times the diameter).

SVQC

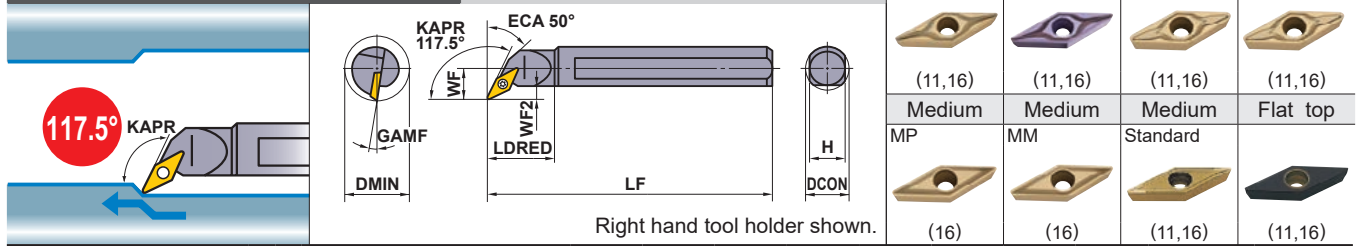
VC inserts





Order Number	Stock		Insert Number	Dimensions(mm)								*  	
	R	L		DCON	LF	LDRED	WF	WF2	H	GAMF	DMIN	Clamp Screw	Wrench
S16MSVQCR/L11	●	●	1103	16	150	25	11	3.9	14	7°	20	TS25	TKY08F
S20QSVQCR/L11	●	●	VCMW	20	180	32	13	4.4	18	7°	25	TS25	TKY08F
S25RSVQCR/L16	☆	●	VCMT	25	200	40	17	6.9	23	5°	32	TS4	TKY15F
S32SSVQCR/L16	☆	●	VCGW	32	250	50	22	8.4	30	5°	40	TS4	TKY15F
S40TSVQCR16	☆	●	VCGT	40	300	63	27	9.4	37	5°	50	TS4	TKY15F

* Clamp Torque (N · m) : TS25=1.0, TS4=3.5

CSVQC

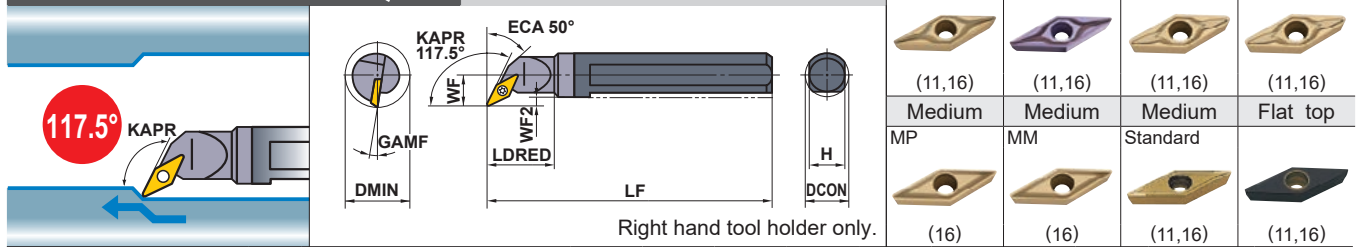
Carbide shank VC inserts



Order Number	Stock		Insert Number	Dimensions(mm)								*  	
	R	L		DCON	LF	LDRED	WF	WF2	H	GAMF	DMIN	Clamp Screw	Wrench
C16RSVQCR11	●	●	1103	16	200	25	11	3.1	14	7°	20	TS25	TKY08F
C20SSVQCR11	●	●	VCMW	20	250	32	13	3.1	18	7°	25	TS25	TKY08F
C25TSVQCR16	☆	●	VCMT	25	300	40	17	4.9	23	5°	32	TS4	TKY15F

* Clamp Torque (N · m) : TS25=1.0, TS4=3.5

Note 1) The insert photos are only examples. The letters refer to the chip breaker and the dimension refers to the inscribed circle.

Note 2) Dimensions shown for insert corner RE 0.4.(Model of ☆ Mark is RE 0.8)

Note 3) When using insert with right and left hand chip breaker, please use left hand insert for right hand holder and right hand insert for left hand holder.

● : Inventory maintained in Japan.

VC type inserts > A145—A147
CBN & PCD inserts > B050, B064

S [○] SSKC		SC [○] inserts								Finish	Finish	Light	Light		
		Stock		Insert Number		Dimensions(mm)						* Clamp Screw	 Wrench		
		R	L			DCON	LF	LDRED	WF	H	GAMF			DMIN	
						(09)	(09)	(09)	(09)	Medium	Medium			Medium	Flat top
						(09,12)	(09,12)	Standard	(09,12)	(09,12)	(09,12)				
Order Number															
S16MSSKCR/L09 ☆	●●		SCMW	09T3 [○]	16	150	25	11	14	7°	20	TS4	TKY15F		
S20QSSKCR/L09 ☆	●●		SCMT	09T3 [○]	20	180	32	13	18	7°	25	TS4	TKY15F		
S25RSSKCR/L12 ☆	●●			1204 [○]	25	200	40	17	23	5°	32	TS5	TKY25F		

* Clamp Torque (N · m) : TS4=3.5, TS5=7.5

S [○] SVUC		VC [○] inserts								Finish	Finish	Light	Light		
		Stock		Insert Number		Dimensions(mm)						* Clamp Screw	 Wrench		
		R	L			DCON	LF	LDRED	WF	WF2	H			GAMF	DMIN
						(11,16)	(11,16)	(11,16)	(11,16)	Medium	Medium			Medium	Flat top
						(16)	(16)	(11,16)	(11,16)						
Order Number															
S20QSVUCR/L11	●●		VCMW	1103 [○]	20	180	32	13	4.4	18	7°	25	TS25	TKY08F	
S25RSVUCR/L16 ☆	●●		VCMT	1604 [○]	25	200	40	17	6.9	23	5°	32	TS4	TKY15F	
S32SSVUCR/L16 ☆	●●		VCGW	1604 [○]	32	250	50	22	8.4	30	5°	40	TS4	TKY15F	
S40TSVUCR/L16 ☆	●●		VCGT	1604 [○]	40	300	63	27	9.4	37	5°	50	TS4	TKY15F	

* Clamp Torque (N · m) : TS25=1.0, TS4=3.5

RECOMMENDED CUTTING CONDITIONS

Steel Shank			l/d ≤ 3			l/d = 3-4 (Shank Diameter ≥ 25mm)		
Carbide Shank			l/d ≤ 5			l/d = 6-7		
Workpiece Material	Hardness	Cutting Mode	Cutting Speed (m/min)	Feed (mm/rev)	Depth of Cut (mm)	Cutting Speed (m/min)	Feed (mm/rev)	Depth of Cut (mm)
P Carbon Steel Alloy Steel	180-350HB	Light Cutting	130 (90-160)	0.1 (0.05-0.15)	0.2	120 (80-150)	0.1 (0.05-0.15)	0.2
		Medium Cutting	90 (60-120)	0.25 (0.15-0.35)	-3.0	80 (50-110)	0.15 (0.1-0.2)	-1.5
M Stainless Steel	≤200HB	Light Cutting	140 (100-180)	0.1 (0.05-0.15)	0.2	140 (100-180)	0.1 (0.05-0.15)	0.2
		Medium Cutting	70 (50-90)	0.2 (0.15-0.25)	-2.0	60 (40-80)	0.15 (0.1-0.2)	-1.0
N Aluminium Alloy	-	Light Cutting	300 (200-400)	0.1 (0.05-0.15)	0.2	300 (200-400)	0.1 (0.05-0.15)	0.2
		Medium Cutting	200 (150-250)	0.1 (0.05-0.15)	-2.0	200 (150-250)	0.1 (0.05-0.15)	-1.5

SC[○] type inserts > A132, A133
 VC[○] type inserts > A145-A147
 CBN & PCD inserts > B050, B064

SPARE PARTS > P001
 TECHNICAL DATA > Q001

BORING BARS

S TYPE BORING BARS

- The minimum cutting diameter is from $\phi 20$.
- ISO standard.
- 7° positive insert.
- Screw-on type.

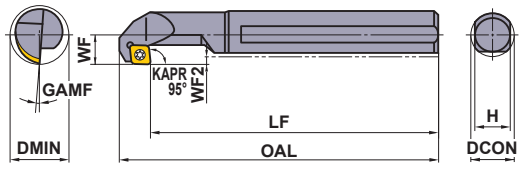
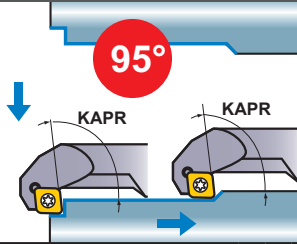

SCZC

CC inserts



Right hand tool holder shown.

Finish	Finish	Light	Light
FP (06,09)	FM (06,09)	LP (06,09)	LM (06,09)
Medium	Medium	Flat top	CBN/PCD
MP (06,09)	MM (06,09)	(06,09)	(06,09)

Order Number	Stock		Insert Number	Dimensions(mm)								*  		
	R	L		DCON	OAL	LF	WF	WF2	H	GAMF	DMIN	Clamp Screw	Wrench	
S16MSCZCR/L06	●	●	CC B CC H CC T CC W	0602	16	161	150	11	3	14	10°	20	TS25	TKY08F
S20QSCZCR/L09	●	●	CC B CC H CC T CC W	09T3	20	198	180	13	3	18	7°	25	TS4	TKY15F

Note 1) The insert photos are only examples. The letters refer to the chip breaker and the dimension refers to the inscribed circle.

Note 2) When using insert with right and left hand chip breaker, please use right hand insert for right hand holder and left hand insert for left hand holder.

* Clamp Torque (N · m) : TS25=1.0, TS4=3.5

BORING BARS

RECOMMENDED CUTTING CONDITIONS









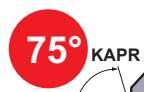
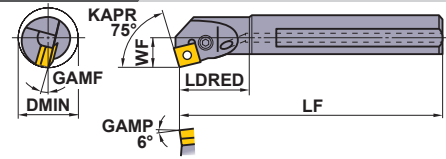

Workpiece Material	Hardness	Cutting Mode	l/d ≤ 3		
			Cutting Speed (m/min)	Feed (mm/rev)	Depth of Cut (mm)
P Carbon Steel Alloy Steel	180–350HB	Light Cutting	130 (90–160)	0.1 (0.05–0.15)	0.2
		Medium Cutting	90 (60–120)	0.25 (0.15–0.35)	–3.0
M Stainless Steel	≤200HB	Light Cutting	140 (100–180)	0.1 (0.05–0.15)	0.2
		Medium Cutting	70 (50–90)	0.2 (0.15–0.25)	–2.0
N Aluminium Alloy	—	Light Cutting	300 (200–400)	0.1 (0.05–0.15)	0.2
		Medium Cutting	200 (150–250)	0.1 (0.05–0.15)	–2.0

● : Inventory maintained in Japan.









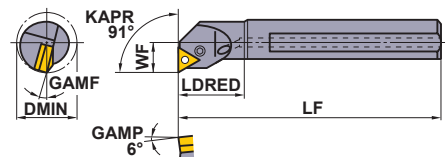

CC type inserts > A114–A121
CBN & PCD inserts > B040–B042, B059

P TYPE BORING BARS

- The minimum cutting diameter is from $\phi 25$.
- ISO standard.
- Economical negative insert.
- Lever lock type.

A○○○PSKN		With coolant hole		SN○○inserts		Finish	Light	Medium	Medium											
						FP  (12)	LP  (12)	MP  (12)	MH  (12)											
						Medium Standard  (09,12)	Stainless MM  (12)	G class R/L  (09,12)	CBN/PCD  (12)											
Order Number	Stock		Insert Number	Dimensions(mm)							Tools									
	R	L		DCON	LF	LDRED	WF	H	GAMF	DMIN	Shim	Shim Pin	Clamp Lever	Clamp Screw	Wrench	Plug	Clamp Pin	Pin	Screw	
A20QPSKNR/L09	●	●	SNMA SNMG 0903○○	20	180	32	13	18	13°	25	—	—	—	—	HKY15R HKY25R	HGM-PT1/8	HP3T	P208AM	HSS03005	
A25RPSKNR/L12	●	●	SNMM SNGA SNGG 1204○○	25	200	40	17	23	13°	32	MLSP42	—	—	—	HKY15R HKY30R	HGM-PT1/4	HP43	P210AM	HSS03005	
A32SPSKNR/L12	●	●	SNMA SNMG 1204○○	32	250	50	22	30	13°	44	LLSSN42	LLP14	LLCL14	LLCS108S	HKY30R	HGM-PT3/8	—	—	—	

*1 Pin Lock Type : A20QPSKNR/L09, A25RPSKNR/L12
 *2 Clamp Torque (N · m) : LLCS108S=3.3, HP3T=2.2, HP43=3.3

A○○○PTFN		With coolant hole		TN○○inserts		Finish	Light	Medium	Medium											
						FP  (16)	LP  (16, 22)	MP  (16,22)	MH  (16,22)											
						Medium Standard  (16,22)	Stainless MM  (16,22)	G class R/L  (16,22)	CBN/PCD  (16,22)											
Order Number	Stock		Insert Number	Dimensions(mm)							Tools									
	R	L		DCON	LF	LDRED	WF	H	GAMF	DMIN	Shim	Shim Pin	Clamp Lever	Clamp Screw	Wrench	Plug	Clamp Pin	Pin	Screw	
A20QPTFNR/L16	●	●	TNMA TNMG 1604○○	20	180	32	13	18	15°	25	—	—	—	—	HKY15R HKY25R	HGM-PT1/8	HP31	P208AM	HSS03005	
A25RPTFNR/L16	●	●	TNMM TNGA TNGG TNGH 1604○○	25	200	40	17	23	13°	32	MLTP32	—	—	—	HKY15R HKY25R	HGM-PT1/4	HP33	P208AM	HSS03005	
A32SPTFNR/L16	●	●	TNMA TNMG 1604○○	32	250	50	22	30	13°	44	LLSTN32	LLP13	LLCL13	LLCS106	HKY25R	HGM-PT3/8	—	—	—	
A40TPTFNR/L22	●	●	TNMM TNGA TNGG TNGH 2204○○	40	300	63	27	37	10°	54	LLSTN42	LLP14	LLCL14	LLCS108S	HKY30R	HGM-PT3/8	—	—	—	
A50UPTFNR/L22	●	●	TNMA TNMG 2204○○	50	350	80	35	47	9°	70	LLSTN42	LLP14	LLCL14	LLCS108S	HKY30R	HGM-PT3/8	—	—	—	

*1 Pin Lock Type : A20QPTFNR/L16, A25RPTFNR/L16
 *2 Clamp Torque (N · m) : LLCS106=2.2, LLCS108S=3.3, HP31=2.2, HP33=2.2

RECOMMENDED CUTTING CONDITIONS

Workpiece Material	Hardness	Cutting Mode	$l/d \leq 3$		
			Cutting Speed (m/min)	Feed (mm/rev)	Depth of Cut (mm)
P Carbon Steel Alloy Steel	180—350HB	Medium Cutting	110 (80—140)	0.25 (0.1—0.4)	—5.0
M Stainless Steel	≤ 200 HB	Medium Cutting	80 (60—100)	0.2 (0.1—0.3)	—4.0
K Gray Cast Iron	Tensile Strength ≤ 350 MPa	Medium Cutting	80 (60—100)	0.25 (0.1—0.4)	—5.0

Note 1) The insert photos are only examples. The letters refer to the chip breaker and the dimension refers to the inscribed circle.

Note 2) Dimensions shown for insert corner RE 0.8.

Note 3) When using insert with right and left hand chip breaker, please use left hand insert for right hand holder and right hand insert for left hand holder.

SN○○ type inserts	> A089—A094
TN○○ type inserts	> A095—A101
CBN & PCD inserts	> B031—B034, B056

SPARE PARTS	> P001
TECHNICAL DATA	> Q001

BORING BARS

P TYPE BORING BARS

- The minimum cutting diameter is from $\phi 20$.
- ISO standard.
- Economical negative insert.
- Lever lock type.

A○○○PDUN		With coolant hole DN○○inserts										Finish									
												FP	Light	Medium	Medium						
												(15)	(11, 15)	(15)	(15)						
												Medium	Stainless	G class	CBN/PCD						
												(11,15)	(15)	(15)	(15)						
Order Number	Stock		Insert Number	Dimensions(mm)								Tools									
	R	L		DCON	LF	LDRED	WF	F2	H	GAMF	DMIN	Shim	Shim Pin	Clamp Lever	Clamp Screw	Wrench	Plug	Clamp Pin	Pin	Screw	
A20QPDUNR/L11	●	●	DNMA	1104	20	180	32	15	6.4	18	13°	26	—	—	LLCL23S	LLCS125	HKY20R	HGM-PT1/8	—	—	—
A25RPDUNR/L11	●	●	DNMA	1104	25	200	40	17	6.9	23	15°	32	LLSDN32	LLP13	LLCL23	LLCS106	HKY25R	HGM-PT1/4	—	—	—
A25RPDUNR/L15	●	●	DNMG	1504	25	200	40	17	6.9	23	13°	32	MLDP42	—	—	—	HKY15R HKY30R	HGM-PT1/4	HP43	P210AM	HSS03005
A32SPDUNR/L11	●	●	DNMX	1104	32	250	50	22	8.4	30	13°	44	LLSDN32	LLP13	LLCL23	LLCS106	HKY25R	HGM-PT3/8	—	—	—
A32SPDUNR/L15	●	●	DNMM	1104	32	250	50	22	8.4	30	13°	44	LLSDN42	LLP14	LLCL24	LLCS108S	HKY30R	HGM-PT3/8	—	—	—
A40TPDUNR/L15	●	●	DNGA	1504	40	300	63	27	9.4	37	10°	54	LLSDN42	LLP14	LLCL24	LLCS108S	HKY30R	HGM-PT3/8	—	—	—
A50UPDUNR/L15	●	●	DNGG	1504	50	350	80	35	12.4	47	9°	70	LLSDN42	LLP14	LLCL24	LLCS108S	HKY30R	HGM-PT3/8	—	—	—

*1 Pin Lock Type : A25RPDUNR/L15

*2 Clamp Torque (N · m) : LLCS125=1.5, LLCS106=2.2, LLCS108S=3.3, HP43=3.3

A○○○PCLN		With coolant hole CN○○inserts										Finish								
												FP	Light	Light	Medium					
												(12)	(12)	(12)	(12)					
												Medium	Medium	Stainless	CBN/PCD					
												(12)	(09,12)	(12)	(12)					
Order Number	Stock		Insert Number	Dimensions(mm)								Tools								
	R	L		DCON	LF	LDRED	WF	H	GAMF	DMIN	Shim	Shim Pin	Clamp Lever	Clamp Screw	Wrench	Plug	Clamp Pin	Pin	Screw	
A16MPCLNR/L09	●	●	—	09T3	16	150	25	11	14	15°	20	—	—	LLCL13S	LLCS105	HKY20R	HGM-PT1/8	—	—	—
A20QPCLNR/L09	●	●	—	09T3	20	180	32	13	18	13°	25	—	—	—	—	HKY25R HKY15R	HGM-PT1/8	HP3T	P208AM	HSS03005
A20QPCLNR/L09N	●	●	CNMA	09T3	20	180	32	13	18	13°	25	—	—	LLCL13S	LLCS105	HKY20R	HGM-PT1/8	—	—	—
A25RPCLNR/L09	●	●	CNMG	09T3	25	200	40	17	23	13°	32	—	—	LLCL13S	LLCS105	HKY20R	HGM-PT1/4	—	—	—
A25RPCLNR/L12	●	●	CNMM	09T3	25	200	40	17	23	13°	32	MLCP42	—	—	—	HKY30R HKY15R	HGM-PT1/4	HP43	P210AM	HSS03005
A32SPCLNR/L12	●	●	CNGA	1204	32	250	50	22	30	13°	44	LLSCN42	LLP14	LLCL14	LLCS108S	HKY30R	HGM-PT3/8	—	—	—
A40TPCLNR/L12	●	●	CNGG	1204	40	300	63	27	37	10°	54	LLSCN42	LLP14	LLCL14	LLCS108S	HKY30R	HGM-PT3/8	—	—	—
A50UPCLNR12	●	●	CNGM	1204	50	350	80	35	47	10°	63	LLSCP42	LLP14	LLCL14	LLCS108S	HKY30R	HGM-PT3/8	—	—	—

*1 Pin Lock Type : A20QPCLNR/L09, A25RPCLNR/L12

*2 Clamp Torque (N · m) : LLCS105=1.5, LLCS106=2.2, LLCS108S=3.3, HP3T=2.2, HP43=3.3

*3 When replacing clamp Lever LLCL13S, please consider purchasing lever spring HLS2 as necessary.

Note 1) The insert photos are only examples. The letters refer to the chip breaker and the dimension refers to the inscribed circle.

Note 2) Dimensions shown for insert corner RE 0.8.

Note 3) When using insert with right and left hand chip breaker, please use left hand insert for right hand holder and right hand insert for left hand holder.

● : Inventory maintained in Japan.

DN○○ type inserts > A081—A087

CN○○ type inserts > A074—A080

CBN & PCD inserts > B022—B030, B055

A○○○PWLN			With coolant hole							WN○○inserts				Light	Medium
														LP	MP
														(06)	(06)
										Stainless					
										MM				(06)	
										Right hand tool holder shown.					
Order Number	Stock		Insert Number	Dimensions(mm)								*2		*1	
	R	L		DCON	LF	LDRED	WF	H	GAMF	DMIN	Clamp Lever	Clamp Screw	Wrench	Plug	
A16MPWLN/L06	●	●	WNMG	06T3○○	16	150	25	11	14	15°	20	LLCL13S	LLCS105	HKY20R	HGM-PT1/8
A20QPWLN/L06	●	●		06T3○○	20	180	32	13	18	13°	25	LLCL13S	LLCS105	HKY20R	HGM-PT1/8
A25RPWLN/L06	●	●		06T3○○	25	200	40	17	23	13°	32	LLCL13S	LLCS105	HKY20R	HGM-PT1/4

*1 Clamp Torque (N · m) : LLCS105=1.5

*2 When replacing clamp Lever LLCL13S, please consider purchasing lever spring HLS2 as necessary.

A○○○PDQN			With coolant hole							DN○○inserts				Finish	Light	Medium	Medium				
														FP	LP	MP	MH				
														(15)	(15)	(15)	(15)				
										Medium				Standard	Stainless	G class	CBN/PCD				
										*1 Pin Lock Type				(15)	(15)	(15)	(15)				
Order Number	Stock		Insert Number	Dimensions(mm)								*2		*2							
	R	L		DCON	LF	LDRED	WF	WF2	H	GAMF	DMIN	Shim	Shim Pin	Clamp Lever	Clamp Screw	Wrench	Plug	Clamp Pin	Pin	Screw	
A25RPDQNR/L15	●	●	DNMA	1504○○	25	200	40	17	6.9	23	13°	32	MLDP42	—	—	—	HKY15R	HGM-PT1/4	HP43	P210AM	HSS03005
A32SPDQNR/L15	●	●	DNMG	1504○○	32	250	50	22	8.4	30	13°	44	LLSDN42	LLP14	LLCL24	LLCS108S	HKY30R	HGM-PT3/8	—	—	—
A40TPDQNR/L15	●	●	DNMM	1504○○	40	300	63	27	9.4	37	10°	54	LLSDN42	LLP14	LLCL24	LLCS108S	HKY30R	HGM-PT3/8	—	—	—
A50UPDQNR15	●	●	DNGA	1504○○	50	350	80	35	12.4	47	9°	70	LLSDN42	LLP14	LLCL24	LLCS108S	HKY30R	HGM-PT3/8	—	—	—
			DNGG																		
			DNGM																		

*1 Pin Lock Type : A25RPDQNR/L15

*2 Clamp Torque (N · m) : LLCS108S=3.3, HP43=3.3

RECOMMENDED CUTTING CONDITIONS

Workpiece Material	Hardness	Cutting Mode	l/d ≤ 3		
			Cutting Speed (m/min)	Feed (mm/rev)	Depth of Cut (mm)
P Carbon Steel Alloy Steel	180—350HB	Medium Cutting	110 (80—140)	0.25 (0.1—0.4)	—5.0
M Stainless Steel	≤200HB	Medium Cutting	80 (60—100)	0.2 (0.1—0.3)	—4.0
K Gray Cast Iron	Tensile Strength ≤350MPa	Medium Cutting	80 (60—100)	0.25 (0.1—0.4)	—5.0

WN○○ type inserts > A106—A109

DN○○ type inserts > A081—A087

CBN & PCD inserts > B026—B030, B055

SPARE PARTS > P001

TECHNICAL DATA > Q001

BORING BARS

P TYPE BORING BARS

- The minimum cutting diameter is from $\phi 32$.
- ISO standard.
- Economical negative insert.
- Lever lock type.

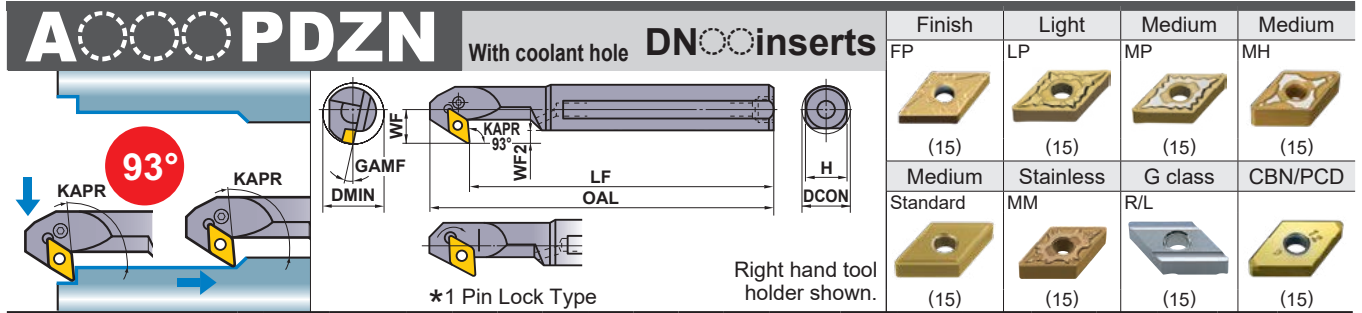

Order Number	Stock		Insert Number	Dimensions(mm)										Tools							
	R	L		DCON	OAL	LF	WF	WF2	H	GAMF	DMIN	Shim	Shim Pin	Clamp Lever	Clamp Screw	Wrench	Plug	Clamp Pin	Pin	Screw	
A25RPDZNR/L15	●	●	DNMA DNMG	1504	25	225	200	17	6.7	23	13°	32	MLDP42	—	—	—	HKY15R HKY30R	HGM-PT1/4	HP43	P210AM	HSS03005
A32SPDZNR/L15	●	●	DNMX DNMM	1504	32	275	250	22	8.2	30	13°	40	LLSDN42	LLP14	LLCL24	LLCS108S	HKY30R	HGM-PT3/8	—	—	—
A40TPDZNR/L15	●	●	DNGA DNGG	1504	40	325	300	27	9.2	37	10°	50	LLSDN42	LLP14	LLCL24	LLCS108S	HKY30R	HGM-PT3/8	—	—	—
A50UPDZNR/L15	●	●	DNGM	1504	50	375	350	35	12.2	47	9°	63	LLSDN42	LLP14	LLCL24	LLCS108S	HKY30R	HGM-PT3/8	—	—	—

*1 Pin Lock Type : A25RPDZNR/L15

*2 Clamp Torque (N • m) : LLCS108S=3.3, HP43=3.3

Note 1) The insert photos are only examples. The letters refer to the chip breaker and the dimension refers to the inscribed circle.

Note 2) Dimensions shown for insert corner RE 0.8.

Note 3) When using insert with right and left hand chip breaker, please use right hand insert for right hand holder and left hand insert for left hand holder.

RECOMMENDED CUTTING CONDITIONS

Workpiece Material	Hardness	Cutting Mode	l/d ≤ 3		
			Cutting Speed (m/min)	Feed (mm/rev)	Depth of Cut (mm)
P Carbon Steel Alloy Steel	180–350HB	Medium Cutting	110 (80–140)	0.25 (0.1–0.4)	–5.0
M Stainless Steel	≤200HB	Medium Cutting	80 (60–100)	0.2 (0.1–0.3)	–4.0
K Gray Cast Iron	Tensile Strength ≤350MPa	Medium Cutting	80 (60–100)	0.25 (0.1–0.4)	–5.0

● : Inventory maintained in Japan.

DN type inserts > A081–A087

CBN & PCD inserts > B026–B030, B055

M TYPE BORING BARS

- The minimum cutting is from $\phi 63$.
- Negative trigon shape insert.
- Double clamp type.
- l/d is 3 times the diameter.

A○○○MWLNR		With coolant hole WN○○inserts		Finish	Light	Medium	Medium											
				FP	LP	MP	MH											
				(08)	(08)	(08)	(08)											
				Medium	Medium to Rough	Stainless												
				Standard	RP	MM												
				(08)	(08)	(08)												
Order Number	Stock	Insert Number	Dimensions(mm)															
	R		DCON	LF	LDRED	WF	H	GAMF	DMIN	Shim	Shim Pin	Clamp Bridge	Side Lock Plate	Spring	Clamp Screw	Wrench	Plug	
A50UMWLN08	●	WNMA WNMG WNGA	0804○○	50	350	80	35	63	9°	63	WPS WC43	CCP44	CCK13	CPT24	MES2	SLCS105	HKY25R HKY40R	HGM- PT3/8

*1 Clamp Torque (N • m) : SLCS105=7.0

Note 1) The insert photos are only examples. The letters refer to the chip breaker and the dimension refers to the inscribed circle.
 Note 2) Dimensions shown for insert corner RE 0.8.

RECOMMENDED CUTTING CONDITIONS

Workpiece Material	Hardness	Cutting Mode	$l/d \leq 3$		
			Cutting Speed (m/min)	Feed (mm/rev)	Depth of Cut (mm)
P Carbon Steel Alloy Steel	180–350HB	Medium Cutting	110 (80–140)	0.25 (0.1–0.4)	–5.0
M Stainless Steel	≤ 200 HB	Medium Cutting	80 (60–100)	0.2 (0.1–0.3)	–4.0
K Gray Cast Iron	Tensile Strength ≤ 350 MPa	Medium Cutting	80 (60–100)	0.25 (0.1–0.4)	–5.0

WN○○ type inserts > A106–A110
 CBN inserts > B037

BORING BARS







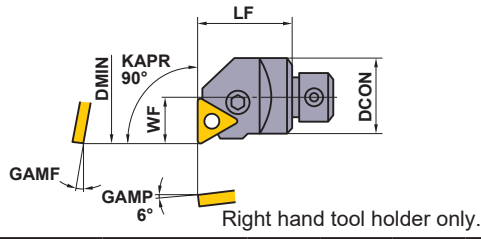
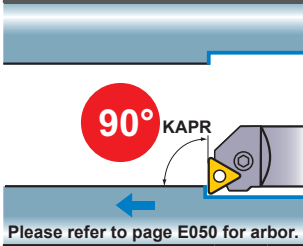

D TYPE BORING HEAD





- The minimum cutting diameter is from $\phi 40$.
- Economical negative insert.
- Lever lock type.
- Exchangeable head type.

DPTF

TN inserts



Finish	Light	Medium	Medium
FP  (16)	LP  (16,22)	MP  (16,22)	MH  (16,22)
Medium Standard  (16,22)	Stainless MM  (16,22)	G class R/L  (16,22)	CBN/PCD  (16)

Order Number	Stock R	Insert Number	Dimensions(mm)					KAPR	DMIN					
			DCON	LF	WF	GAMF	GAMP							
DPTF132R	●	TN A TN G TN M	1604	32	40	20	12°	40	LLSTN32	LLP13	LLCL13	LLCS106	HKY25R	
DPTF140R	●	TN A TN G TN M	2204	40	50	25	10°	50	LLSTN42	LLP14	LLCL14	LLCS108	HKY30R	







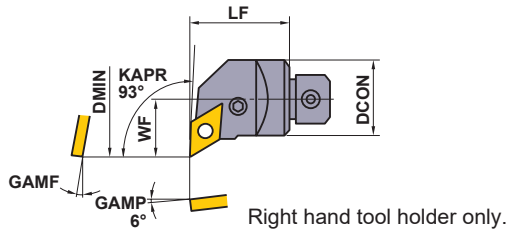
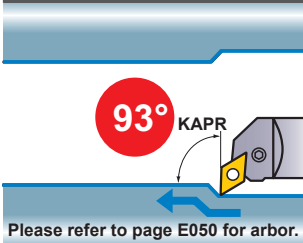

* Clamp Torque (N · m) : LLCS106=2.2, LLCS108=3.3





BORING BARS

DPDU

DN inserts



Finish	Light	Medium	Medium
FP  (15)	LP  (15)	MP  (15)	MH  (15)
Medium Standard  (15)	Stainless MM  (15)	G class L  (15)	CBN/PCD  (15)

Order Number	Stock R	Insert Number	Dimensions(mm)					KAPR	DMIN					
			DCON	LF	WF	GAMF	GAMP							
DPDU132R	●	DN A DN G DN M DN X	1504	32	40	25	10°	50	LLSDN42	LLP14	LLCL24	LLCS108	HKY30R	
DPDU140R	●	DN A DN G DN M DN X	1504	40	50	30	9°	60	LLSDN42	LLP14	LLCL24	LLCS108	HKY30R	

* Clamp Torque (N · m) : LLCS108=3.3

Note 1) The insert photos are only examples. The letters refer to the chip breaker and the dimension refers to the inscribed circle.

Note 2) Dimensions shown for insert corner RE 0.8.











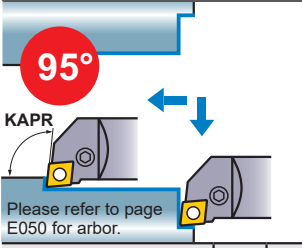
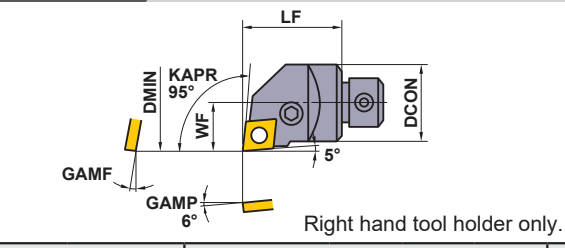



Note 3) When using insert with right and left hand chip breaker, please use left hand insert for right hand holder and right hand insert for left hand holder.

● : Inventory maintained in Japan.











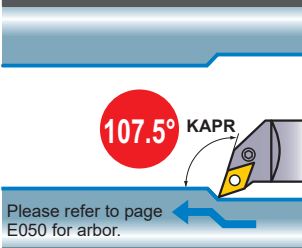
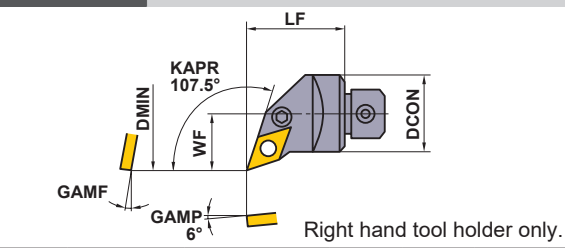



TN type inserts > A095 – A101

DN type inserts > A081 – A087

CBN & PCD inserts > B026 – B030, B032 – B034, B055, B056

DPCL			CN \odot inserts						Finish	Light	Light	Light	
 <p>95°</p> <p>KAPR</p> <p>Please refer to page E050 for arbor.</p>	 <p>LF</p> <p>DCON</p> <p>KAPR 95°</p> <p>WF</p> <p>5°</p> <p>GAMF</p> <p>GAMP 6°</p> <p>DMIN</p> <p>Right hand tool holder only.</p>	FP	SA	LP	LM	 (12)	 (12)	 (12)	 (12)				
		Medium	Medium	Stainless	CBN/PCD	MP	Standard	MM	 (12)	 (12)	 (12)	 (12)	
Order Number	Stock	Insert Number	Dimensions(mm)										
	R		DCON	LF	WF	GAMF	DMIN	Shim	Shim Pin	Clamp Lever	Clamp Screw	Wrench	
DPCL132R	●	CN \odot A CN \odot G CN \odot M	1204 \odot	32	40	20	12°	40	LLSCN42	LLP14	LLCL14	LLCS108	HKY30R
DPCL140R	●	CN \odot A CN \odot G CN \odot M	1204 \odot	40	50	25	10°	50	LLSCN42	LLP14	LLCL14	LLCS108	HKY30R

* Clamp Torque (N · m) : LLCS108=3.3

DPDH			DN \odot inserts						Finish	Light	Medium	Medium	
 <p>107.5°</p> <p>KAPR</p> <p>Please refer to page E050 for arbor.</p>	 <p>LF</p> <p>DCON</p> <p>KAPR 107.5°</p> <p>WF</p> <p>6°</p> <p>GAMF</p> <p>GAMP 6°</p> <p>DMIN</p> <p>Right hand tool holder only.</p>	FP	LP	MP	MH	 (15)	 (15)	 (15)	 (15)				
		Medium	Stainless	G class	CBN/PCD	Standard	MM	L	 (15)	 (15)	 (15)	 (15)	
Order Number	Stock	Insert Number	Dimensions(mm)										
	R		DCON	LF	WF	GAMF	DMIN	Shim	Shim Pin	Clamp Lever	Clamp Screw	Wrench	
DPDH132R	●	DN \odot A DN \odot G DN \odot M	1504 \odot	32	40	25	10°	50	LLSDN42	LLP14	LLCL24	LLCS108	HKY30R
DPDH140R	●	DN \odot A DN \odot G DN \odot M	1504 \odot	40	50	30	9°	60	LLSDN42	LLP14	LLCL24	LLCS108	HKY30R

* Clamp Torque (N · m) : LLCS108=3.3

RECOMMENDED CUTTING CONDITIONS

Workpiece Material	Hardness	Cutting Mode	l/d ≤ 3			l/d = 3-4		
			Cutting Speed (m/min)	Feed (mm/rev)	Depth of Cut (mm)	Cutting Speed (m/min)	Feed (mm/rev)	Depth of Cut (mm)
P Carbon Steel Alloy Steel	180-350HB	Medium Cutting	110 (80-140)	0.25 (0.1-0.4)	-5.0	110 (80-140)	0.2 (0.1-0.3)	-4.0
M Stainless Steel	≤200HB	Medium Cutting	80 (60-100)	0.2 (0.1-0.3)	-4.0	70 (50-100)	0.15 (0.1-0.25)	-3.0
K Gray Cast Iron	Tensile Strength ≤350MPa	Medium Cutting	80 (60-100)	0.25 (0.1-0.4)	-5.0	80 (60-100)	0.2 (0.1-0.3)	-4.0

CN \odot type inserts > A074-A080
 DN \odot type inserts > A081-A087
 CBN & PCD inserts > B022-B030, B055

SPARE PARTS > P001
 TECHNICAL DATA > Q001

BORING BARS







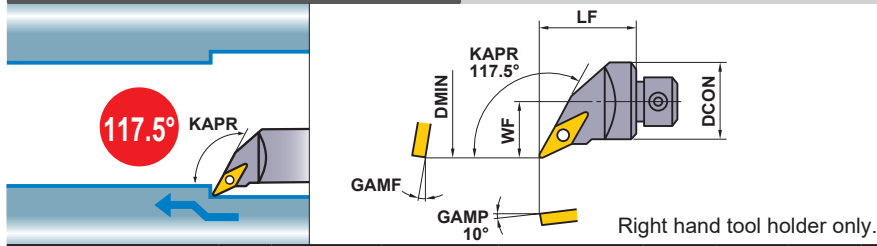

D TYPE BORING HEAD

- The minimum cutting diameter is from $\phi 40$.
- Economical negative insert.
- Lever lock type.
- Exchangeable head type.

DPVP

VN \circ inserts



Finish	Light	Medium	Medium
FP	LP	MP	MH
			
(16)	(16)	(16)	(16)
Stainless	G class	PCD	CBN
MM	L	L-F	
			
(16)	(16)	(16)	(16)

Order Number	Stock	Insert Number	Dimensions(mm)					DICON	Shim	Lock Pin	Lock Screw *	Stop Ring	Wrench
			DCON	LF	WF	GAMF	DMIN						
DPVP132R	●	VN \circ A VN \circ G VN \circ M	1604 \circ	32	40	25	13°	50	PV322	P11S	HSP05008C	E03	HKY25R
DPVP140R	●	VN \circ A VN \circ G VN \circ M	1604 \circ	40	50	30	13°	60	PV322	P11S	HSP05008C	E03	HKY25R

* Clamp Torque (N · m) : HSP05008C=2.5

Note 1) Dimensions shown for insert corner RE 0.8.

BORING BARS

STANDARD ARBOR FOR D TYPE BORING HEAD

① Designation	② Arbor Length (mm)			③ Arbor Diameter (mm)		④ Head Diameter (mm)		
	Symbol	DCON	LF	OAL	Symbol	Diameter(DCON)	Symbol	Diameter(BD)
1		32	260	300	32	32	32	32
		40	310	360	40	40	40	40

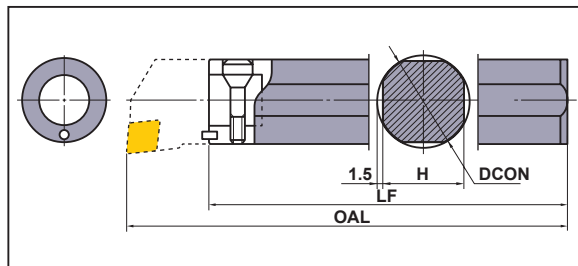

Order Number	Stock	Dimensions (mm)				Set Bolt	Wrench	Head Order Number
		DCON	LF	H	OAL			
B13232	●	32	260	29	300	SD32	HKY60R	DP \circ \circ 132R
B14040	●	40	310	37	360	SD40	HKY60R	DP \circ \circ 140R

● : Inventory maintained in Japan.



VN \circ type inserts > A102–A105
CBN & PCD inserts > B035, B036, B057

AL TYPE BORING BARS

- Suitable for non-ferrous metal.
- 20° positive insert.
- Screw-on type.
- l/d is 6 times the diameter.
- Excellent vibration resistance.
- The minimum cutting diameter is from $\phi 20$.



STFE

TE \odot inserts

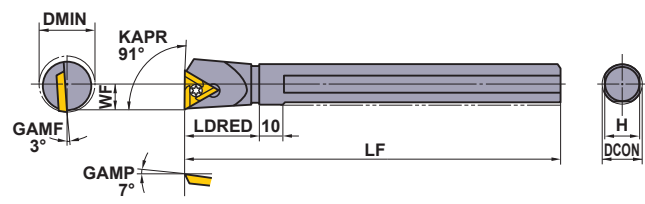
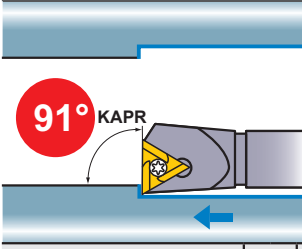
Medium	PCD
R/L  (16)	R/L  (16)
PCD	
 (16)	



Right hand tool holder shown.

Order Number	Stock		Insert Number	Dimensions(mm)						*  		
	R	L		DCON	LF	LDRED	WF	H	DMIN	Clamp Screw	Wrench	
S16RSTFER/L16	●	●	TEGX	1603 \odot	16	200	30	11	14.6	20	FC400890T	TKY10F
S20RSTFER/L16	●	●		1603 \odot	20	200	37	13	18	25	FC400890T	TKY10F
S25SSTFER/L16	●	●		1603 \odot	25	250	40	17	23	32	FC400890T	TKY10F

* Clamp Torque (N · m) : FC400890T=2.5

BORING BARS

RECOMMENDED CUTTING CONDITIONS

Workpiece Material	Grade	Cutting Speed (m/min)	l/d=3		l/d=4		l/d=5		l/d=6	
			Feed (mm/rev)	Depth of Cut (mm)	Feed (mm/rev)	Depth of Cut (mm)	Feed (mm/rev)	Depth of Cut (mm)	Feed (mm/rev)	Depth of Cut (mm)
N Aluminium Alloy	HT110	400 (200-600)	0.15 (0.05-0.25)	-3.0	0.15 (0.05-0.25)	-3.0	0.1 (0.05-0.2)	-2.5	0.1 (0.05-0.2)	-1.0
	MD220	800 (200-1500)	0.15 (0.05-0.25)	-3.0	0.15 (0.05-0.25)	-3.0	0.1 (0.05-0.2)	-2.5	0.1 (0.05-0.2)	-1.0

Note 1) The insert photos are only examples. The letters refer to the chip breaker and the dimension refers to the inscribed circle.

Note 2) Dimensions shown for right corner RE 0.4.

Note 3) When using insert with right and left hand chip breaker, please use left hand insert for right hand holder and right hand insert for left hand holder.

TE \odot type inserts	> A138	SPARE PARTS	> P001
PCD inserts	> B066	TECHNICAL DATA	> Q001